



January 2020

Agricultural Research Partnerships (ARP) Network NOTES

Welcome to ARP Network Quarterly Notes! Our goal is to keep you informed about ARP Network and Agricultural Research Service's current information. We hope that the notes build networking opportunities for businesses to connect with ARP Network Members.

Please help us spread the word by sharing ARP Network Notes with your company contacts, colleagues, other organizations, etc. Thank you!

ARP Network

The ARP Network enlists the help of partners to spark economic development, entrepreneurship and community development. USDA ARS founded the ARP Network to expand the impact of ARS research and provide resources to help companies grow. By combining ARS research expertise with complementary capabilities and talents of partnering organizations, the ARP Network helps stimulate economic growth through technological advancements. The ARP Network matches business needs with ARS innovations and research capabilities and provides business assistant services to help companies and startups solve agricultural problems, develop products and create new jobs. Learn more by visiting us on LinkedIn: <https://www.linkedin.com/in/agricultural-research-partnerships-arp-network-3863a8147>

Federal Laboratory Consortium (FLC) Annual National Meeting

FLC ABOUT SUCCESSES LEARNING CENTER FLCBUSINESS T2 TOOLKIT

2020 National Meeting
Portland, Oregon
April 28-30

Join hundreds of the nation's top technology transfer professionals to learn, make connections and gain insights. The FLC [National Meeting](#), April 28-30 in Portland, Oregon, is one of the most anticipated events in the Technology Transfer Community community.

ARS Partnership and/or Licensing Opportunities

ARS is looking for industry partners interested in commercializing these technologies and/or evaluating them for potential commercial applications through a Cooperative Research and Development Agreement (CRADA). Many of these technologies are also available for licensing

Novel Capture Device for Selective Separation from Complex Mixtures

ARS developed a new class of particles for the selective separation of biological components. These particles are suitable for affinity/immunological magnetic separation and provide many of the same benefits as the commercialized paramagnetic beads, except they were designed to query larger volume samples in a cost-effective manner.

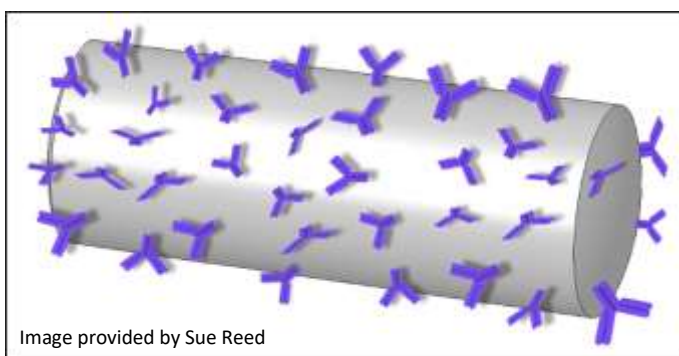

Benefits

- Expands the capabilities of immunomagnetic separation to large volume samples
- Platform-based technology used in conjunction with biorecognition elements for the selective capture of bacteria and other biomolecules
- Low-cost design allows for incorporation into disposable units amendable to automation for high throughput assays

Applications

- This capture device was designed for targeted isolation from complex mixtures, having the same benefits as commercialized paramagnetic particles, except being more suited to large volume applications

ARS Docket no. 68.18. Please contact Jim Poulos: jim.poulos@usda.gov

Reusable Adsorbent for Contaminant Removal

A reusable adsorbent to remove contaminants and pollutants from wastewater and waterways. A fringe of molecular “hairs” gives the material high adsorption capacity. A magnetic component simplifies adsorbent use and reprocessing. The adsorbent can be washed and reused with minimal loss in performance.

Benefits

- Polypeptide “hairs” on adsorbent particle enhance performance
- Simple adsorbent recovery
- Reusability reduces cost and waste

Applications

- Wastewater treatment
- Substitute for activated charcoal
- Removal of contaminants such as dyes and pesticides from water

ARS Docket No. 156.18. Please contact Jim Poulos: jim.poulos@usda.gov

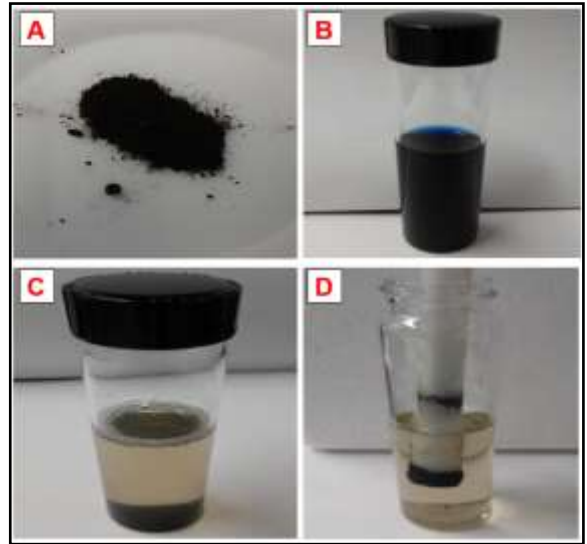

A Gene-Based Interferon Biotherapeutics

ARS constructed a new type I interferon gene expression system to increase interferon production and antiviral potency. This DNA construct can be inserted into gene-expressing vectors to be used as an antiviral biotherapeutic in pigs. The construct can be modified to be used in other animals.

Benefits

- Uses the most potent porcine interferon gene to increase antiviral activity
- Uses a strong porcine promoter for high gene expression
- Includes another porcine gene to extend the duration of interferon production

Applications

- Use alone for inducing rapid protection against virus infection

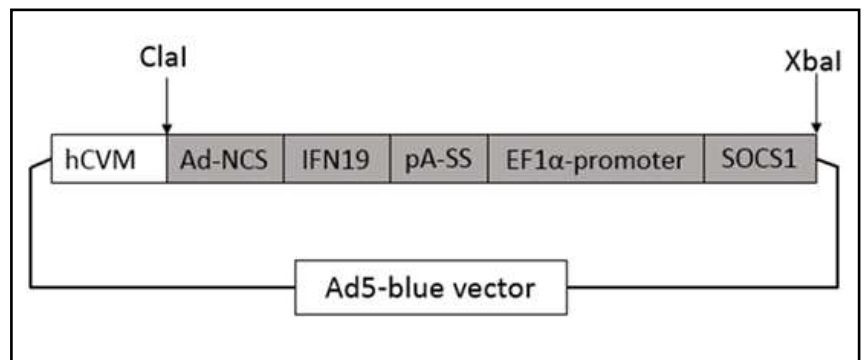

- Combine with vaccines for inducing rapid and long-lasting immune protection

ARS Docket No. 115.17. Please contact Jim Poulos: jim.poulos@usda.gov

Antimicrobial Curing Agents for Epoxies

A bio-based epoxy curing agent has been developed that gives the final cured epoxy polymer good antimicrobial activity against both Gram-positive and Gram-negative bacteria. The manufacturing process involves mixing this curing agent with commercial epoxy resins and hardening the mixture at certain temperatures. The resulting polymer coating doesn't contain any small molecular biocides embedded, but instead inhibits the bacteria by mere contact without releasing any reactive agents.

Benefits

- Renewable
- Inhibits both Gram-negative and Gram-positive bacteria
- Non-volatile and non-migratory
- Good water-resistance

Applications

- Antimicrobial coatings for public sanitations like public bathroom wall coating, flooring or toilet seat coatings
- Coatings for reception desks, countertop, dining tables or biological lab benches.
- Medicine or food packaging materials
- Cosmetics additives to prevent microbial proliferation
- Polymeric disinfectants used for water treatment

ARS Docket No. 107.19. Please contact Jim Poulos: jim.poulos@usda.gov

Methods for Recovery and Reuse of Filtration Media

This invention describes the process for recycling spent filtration media used to filter organic solids from fluids. While the invention specifically focusses on diatomaceous earth filtration media, the methods are applicable to other siliceous filtration media as well.

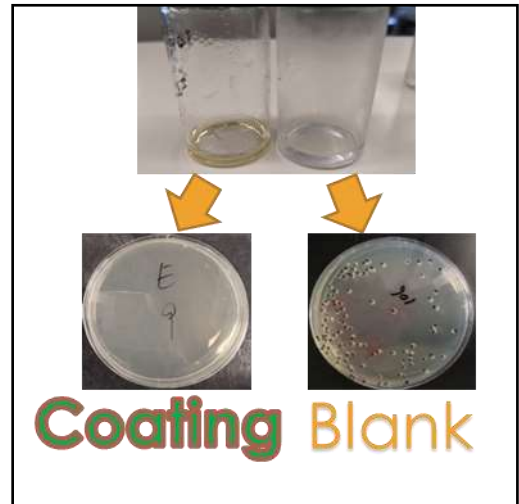

Benefits

- Provides for reduced costs of filtration
- Provides for reuse of a finite resource... a 'greener' approach

Applications

- Diatomaceous earth is used as a filtering agent in many industries due to its unique properties including its large pore size to grain size ratio, and its ability to 'stick' to itself. However, its use is expensive relative to other filtration media.

ARS Docket No. 129.17. Please contact Jim Poulos: jim.poulos@usda.gov

Non-Invasive System and Method to Measure Soil Elements and Locate Subsurface Objects

A neutron-gamma analysis system used as an alternative to traditional chemical analysis that measures soil elements such as soil carbon (C) by depth and can locate subsurface objects. This portable device makes non-invasive measurements using a neutron generator with an associate

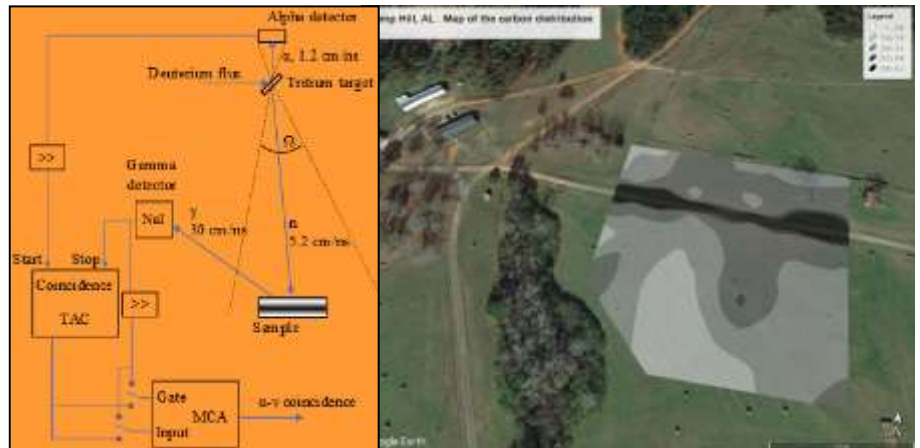

particle alpha detector known as Application of Associated Particle Imaging (API). The results of the invention can be combined with known mapping techniques to generate fast and accurate soil element maps such as C with depth increments.

Benefits

- Soil Carbon determined by depth increments averaged over large field units
- Saves labor and cost of soil samples and laboratory analysis of soil samples
- Soil C maps generated as soon as mapping is complete
- Buried objects can be detected and depth determined

Applications

- Soil C maps (and other nutrients) can be made following soil scanning with no soil disturbance
- Specific buried objects such as explosives or contaminants can be detected and depth determined

ARS Docket No. 61.18. Please contact Cathy Cohn: cathleen.cohn@usda.gov

Novel Polytriglycerides

Polyketone, polyamine and polyimine vegetable oil derivatives from renewable sources enable chelation or removal of heavy metal ions from aqueous solutions. The oil is heavier than water and can be regenerated and recycled after recovery of the heavy metal content.

Benefits

- High molecular mass compared to current neutralization agents
- Made from renewal resources in the form of vegetable oils

Applications

- Potentially used for neutralization, metalworking, metal ion absorption/extraction/sequestration
- Sequestration of toxic metal species from aqueous media and environmental purposes
- Biodegradable lubricating agents

ARS Docket No. 124.19 + 156.17 + 190.13. *Please contact Renee Wagner:*
renee.wagner@usda.gov

System for Non-invasive Measurement of Soil Chlorine

A device for making non-invasive measurements of chlorine elemental content in situ from the surface of the soil. The device is a portable field unit using a neutron generator positioned on the surface of the soil to generate fast neutrons that penetrate the soil. The device makes measurements in a large volume of soil and can determine the Cl content regardless of chemical component present. Results are generated immediately following scanning. The device can be utilized for the remediation of contaminated soil for contaminants such as polychlorinated biphenyl (PCB) and perchlorate.



Benefits

- Non-invasive measurements of Cl content in soil
- Large volume soil sampling and immediate results
- The large sample volume reduces uncertainty from site sampling and immediate results facilitates planning for soil remediation
- Detection of any Cl containing contaminate without specific laboratory analysis

Applications

- This device can be used to detect CI containing contaminants without the costly soil sampling, preparation, and laboratory analysis normally required

ARS Docket No. 125.19 + 112.15. Please contact Cathy Cohn: cathleen.cohn@usda.gov

Antisense Oligo Targets Bacterial Pathogens in Plants and Insects

This invention relates to bactericidal molecules to suppress bacterial pathogens

Benefits

- Provides protection against Bacteria,)

Applications

- Prevent and reduce spread of citrus huanglongbing, HLB and Zebra Chip in potato
- Suppression of other bacterial plant pathogens



Untreated infected

Treated infected

ARS Docket No. 40.17. Please contact Cathy Cohn: cathleen.cohn@usda.gov

RNAi Strategies for Control of Whitefly

A double stranded RNA that targets genes important for the viability of the whitefly. By suppressing expression of key genes, the whitefly dies quickly, reducing whitefly populations on plants treated with these RNA constructs or on modified plants producing the RNAs. Reduced incidence of whitefly numbers and whitefly feeding on plants has the potential to greatly reduce transmission of whitefly-transmitted plant viruses that infect a wide array of crops.



Benefits

- Provides broad plant protection against whitefly, *Bemisia tabaci*, *B. argentifolii*, and biotypes, by reducing populations

- Could result in a reduction in the use of insecticides in crop production
- Can be applied as topical product or incorporated into plant expressed systems

Applications

- Efficacious whitefly suppression to combat pest and the viral pathogens they transmit
- Increase yields by reducing losses to whitefly

ARS Docket No. 105.17. Please contact David Nicholson: david.nicholson@usda.gov

Deeper Rooting1 Gene

The shape of a plant's root system impacts the resources it can access. The DEEPER ROOTING 1 (DRO1) gene assists in modulating the angle at which the roots grow. Knot-out mutations in the DRO1 gene lead to horizontal root growth, while plants that over-expressed DRO1 have more downward root growth.

Benefits

- More downward root growth may lead to increased access to water at deeper soil layers
- Potential for improving plant stability in soil

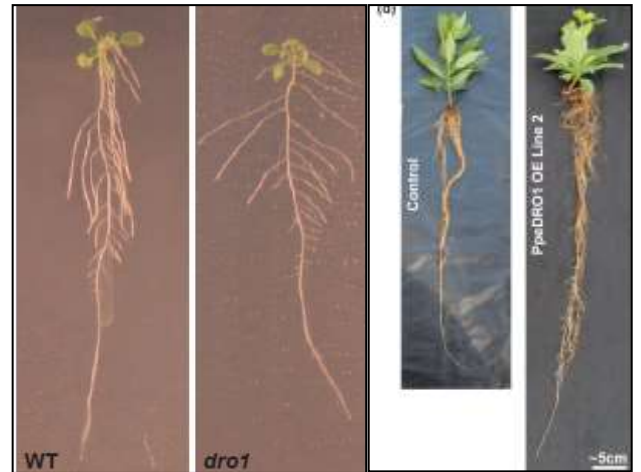

Applications

- Trees and other plants with altered root system shape to better access soil resources such as water and nutrients, as well as potentially improved anchorage

ARS Docket No. 106.15. Please contact Jim Poulos: jim.poulos@ars.usda.gov

Cryogenic Trap

A thermoelectric cryogenic trap system and method used to separate and identify inorganic and organic arsenicals in a vapor stream.

Benefits

- The cryogenic trap is cost effective, sensitive and selective
- No reagents or coolants (i.e. no liquid nitrogen) used. It is a physical approach

Applications

- Monitoring to protect consumers from dietary arsenic exposure

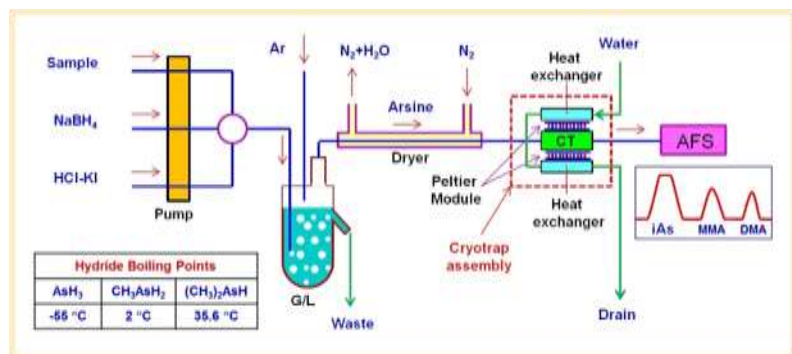

- To uphold regulations and protect consumers, methods capable of inorganic arsenic detection at ng g-1 level are needed. Because rice is such an important crop, it was selected as the model matrix in this work
- Monitoring of environmental pollution
- Pharmacokinetic, clinical and toxicology studies

ARS Docket No. 118.15. Please contact Jim Poulos: jim.poulos@usda.gov

Penicillin Enhancement by Modified Tunicamycins

The penicillins are the most commonly used antibiotics, with >60% utilized in agriculture, but resistance to penicillin is now widespread. The efficacy of penicillins are significantly improved by combining with modified tunicamycins, which are not toxic to eukaryotes. Modified tunicamycins (TunR1 and TunR2) enhance the penicillin efficacy by 32-64 fold, revitalizing penicillin's usage against resistant Gram-positive bacteria.

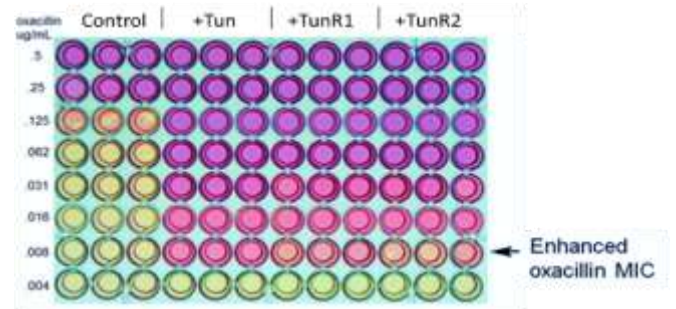

Benefits

- Potent enhancement of medically-important penicillins
- Modifications drastically reduce the toxicity
- The combination of penicillin and modified tunicamycin are more efficacious than either penicillin or modified tunicamycin alone

Applications

- TunR1 and TunR2 are potent penicillin enhancers with new uses in antibiotic formulations for medicine and agriculture

ARS Docket no. 120.16. Please contact Renee Wagner: renee.wagner@ars.usda.gov

Plant-mediated Silencing of a Fatty Acid and Retinol-binding Protein in *Pratylenchus Penetrans*

Fatty acid- and retinol-binding (FAR) proteins are a family of proteins unique to *Pratylenchus Penetrans*, a species of nematodes. This invention consists of a region of the FAR-1 gene from the root lesion nematode that has been made into a dsDNA construct (ds-FAR-1) that is designed to silence the FAR-1 gene of root lesion nematodes. The reproduction of root lesion nematodes



feeding on soybean roots engineered to contain this construct was significantly reduced.

Benefits

- ds-FAR-1 can be used to engineer plants, or apply directly to plants, for resistance to root lesion nematodes
- Plants with resistance to root lesion nematodes decreases the use of fumigants and pesticides from nematode control
- Because the FAR-1 protein is found on in nematodes, application of this technology should not affect non-target organisms such as humans, plants, insects (e.g. bees), etc.

Applications

- The ds-FAR-1 construct may be a useful technology for genetic improvement of plants that are susceptible to root lesion nematodes such as potatoes, soybeans, corn, fruits (apples, raspberries, and cherries), and lilies

ARS Docket No. 199.16. *Please contact Jim Poulos:* jim.poulos@usda.gov

Bio-based Resins/Adhesives for Wood Composites

There has been significant interest in using non-petroleum-based adhesives and resins to fabricate wood composites, particularly for interior uses. Unfortunately, currently available bio-based adhesives derived from soybean meals are more expensive than their petroleum counterparts. ARS has developed methodologies to employ inexpensive by-products from corn, ethanol processing and other feedstocks for production of a more cost-effective bio-based adhesive/resin for this purpose.

Benefits

- Inexpensive to produce
- Excellent adhesive and mechanical properties

Applications

- Building, furniture and manufacturing industries

ARS Docket No. 166.16. *Renee Wagner:* renee.wagner@usda.gov

Available Technologies for Licensing

Each year, approximately 60 new patents are issued by the U.S. Patent Office for USDA inventions. The Office of Technology Transfer (OTT) transfers these inventions through licenses to the private sector for commercialization. Click [here](#) for a link to *recently filed* U.S. patent applications that are available for licensing.

Snapshot of ARS Technology Transfer

A brief information sheet that highlights some ARS Technology Transfer metrics and commercial products resulting from ARS Research. Click [here](#) to read.

Resources for Businesses

Some resources for small businesses at USDA and other Federal agencies. Click [here](#) to read.

Tellus

Tellus is a digital experience that features stories about the cutting-edge work at ARS. **Tellus**, Latin for Earth, reflects the global reach of our efforts to feed a growing population while remaining good stewards of the land. Click [here](#) for the latest articles.



Minnie Finger Lime, a new citrus cultivar developed by Agricultural Research Service scientists.

ARS Latest News

USDA's ARS is a leading source for U.S. agricultural research. The ARS vision is to lead America towards a better future through agricultural research and information. Click [here](#) for the latest news.



Adult female Ambrosia beetles such as this species—the black stem borer (*Xylosandrus germanus*)—farm fungal gardens in the tunnels they make in fruit and ornamental trees.

USDA-ARS YouTube Channel

Did you know that ARS is on YouTube? Explore our new YouTube channel to see how our research touches your life: [USDA-ARS YouTube Channel](#)

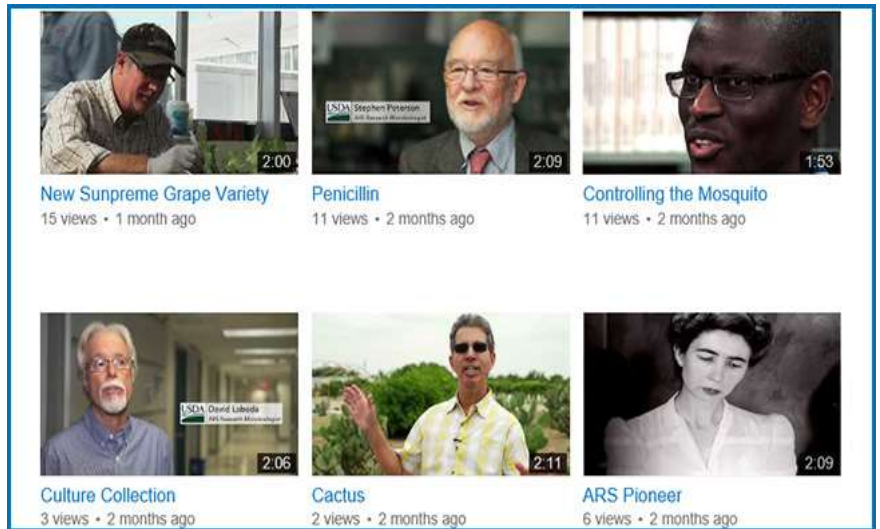

ARS

The Agricultural Research Service (ARS) is USDA's primary internal research agency. ARS conducts research to develop and transfer solutions to agricultural problems that are both national and international in scope. ARS has nearly 2,000 scientists nationwide and a few in overseas locations. ARS scientists carry out 690 research projects on a variety of subjects. ARS has a Congressional mandate to disseminate the research findings of these projects to the American public and other interested parties. Learn more by visiting: <http://www.ars.usda.gov>

Get more information: www.ars.usda.gov

