

**United States
Department of
Agriculture**

Soil
Conservation
Service

Agriculture
Handbook
Number 169

Snow Survey Sampling Guide

Ready Reference

Importance of accuracy	2
Care of sampling equipment	2
Checking equipment	3
Snow course map	5
Assembling sampling tube	6
Field note	7
Measuring location of sampling point	8
Taking sample	10
Removing litter from end of tube	13
Recording snow depth	14
Recording core length	14
Weighing snow samples	14
Recording snow sample weight	16
Calculating water content of snow	19
Calculating density of snow	20
Checking notes	23
Snow freezing in tube	26
Sampling very shallow snow	27
Tubes too short for depth of snow	29
Driving sampler in deep snow	32

Snow Survey Sampling Guide

The purpose of this guide is to promote efficient and accurate snow surveying and to establish uniform sampling procedures.

It is a training and reference guide designed for snow surveyors who use sampling equipment to measure snow accumulation. It explains sampling and recording procedures essential for accurate forecasts of the Nation's water supplies.

Importance of accuracy

Accuracy is essential. A small error in snow sampling can produce a large error in the water supply forecast. An error in measurement affects not only current reports but also analyses of archival data in future years.

Take special care to avoid error while reading snow depth and tube weight. Be sure the core sample represents the full depth of the snow.

Care of sampling equipment

Taking good care of your sampling equipment can make the difference between a good survey and a poor one.

1. Handle the equipment carefully to prevent damage. A four-section sampling set costs more than \$500.

2. Do not cling to the sampling tubes while sampling on steep slopes.
3. Keep the sampling tubes clean and covered inside and out with a thin coating of spray silicone or wax. A coating keeps the snow from adhering to the tube and prevents corrosion.
4. Ice and rock feel and sound similar when struck by the sampling tube. Before you exert pressure, be sure you are striking ice.
5. Keep the cutter sharp and the orifice true to its original diameter. If the cutter is broken or badly worn, ask for a replacement.

Checking equipment

Before leaving headquarters—

1. See that tubes are properly siliconed or waxed.
2. Make sure the coupling threads are clean and that all the tube sections screw together without binding.
3. Check the sampling kit for the following items:
 - Sampling tube sections that match
 - Spanner wrenches
 - Thread protector
 - Driving wrench (optional)
 - Field data notebook (SCS-EN-708)
 - Pencil
 - Weighing scale and cradle
 - Snow course map

- Measuring tape
- Snow Survey Safety Guide
- First aid kit
- Snow Survey Sampling Guide

Snow Sampling Kit

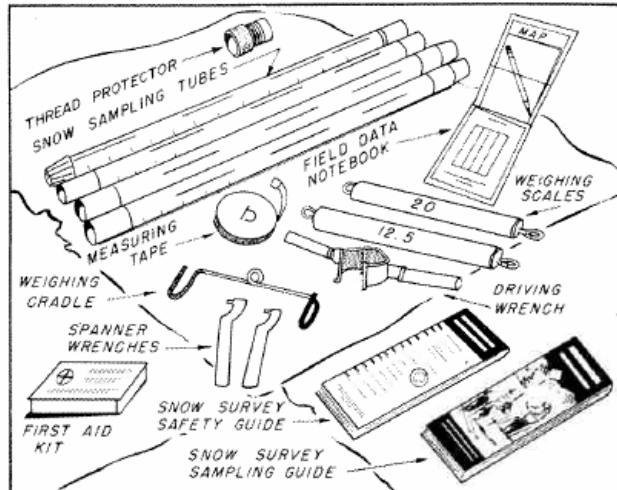

4. Check your oversnow traveling equipment for:

- Goggles
- Skis—running surface, binding, poles, climbers
- Snowshoes—varnish coating, webbing, bindings
- Oversnow vehicle—fuel and oil (see operating manual)

5. Check your clothing and that of your companions. See Snow Survey Safety Guide.

It is much easier to check these items at headquarters, where replacements are available, than at the snow course.

Snow sampling procedures

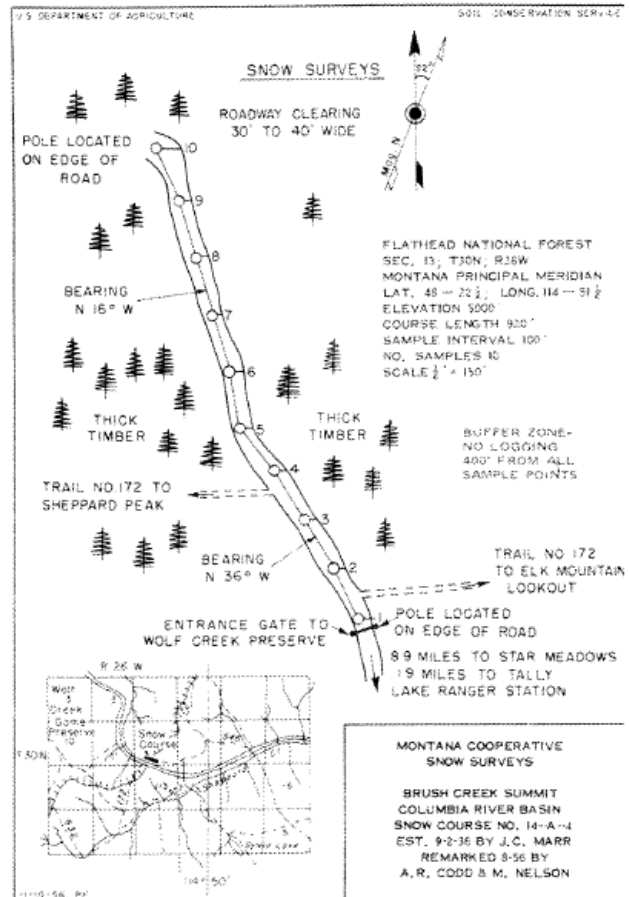

Step 1

Check the location sketch map of the snow course for sampling point No. 1. Do not drive the snow machine on the snow course. Do not walk on the snow course without snowshoes or skis. Keep walking to a minimum.

Step 3
 Fill in heading on field note.

UNITED STATES DEPARTMENT OF AGRICULTURE
 SOIL CONSERVATION SERVICE

SCS-EN-708
 12-79

FEDERAL-STATE-PRIVATE
 COOPERATIVE SNOW SURVEYS

Snow Course Blizzard Ridge
 Drainage Basin Missouri-Gallatin State Montana
 Sampler G. Clagett Note Taker P. E. Farnes
 Date Feb. 28, 1984 Began 1:00 p.m. Ended _____ a.m.
 _____ p.m.



Step 2

Assemble sampling tube, screwing sections together handtight (no wrenches). Make sure the numbers run consecutively throughout the length. Use three or more sections of tubing unless the scale has been adjusted for light weights or accessory weights are added. Add thread protector to top section of tubing.

Sample Number	Depth of Snow Inches	Length of Core Inches	Weight of Tube and Core	Weight of Empty Tube	Water Content Inches	Density Percent	Remarks (See reverse)
<u>1</u>							
<u>2</u>							
<u>3</u>							
<u>4</u>							
<u>5</u>							
<u>6</u>							
<u>7</u>							
<u>8</u>							
<u>9</u>							
<u>10</u>							
<u>10</u>							<u>Total</u>
<u>10</u>							<u>Average</u>

No. of tube sections used _____

Was driving wrench used? _____

No. 1 of _____ sheets. Comp. by _____ Checked by _____

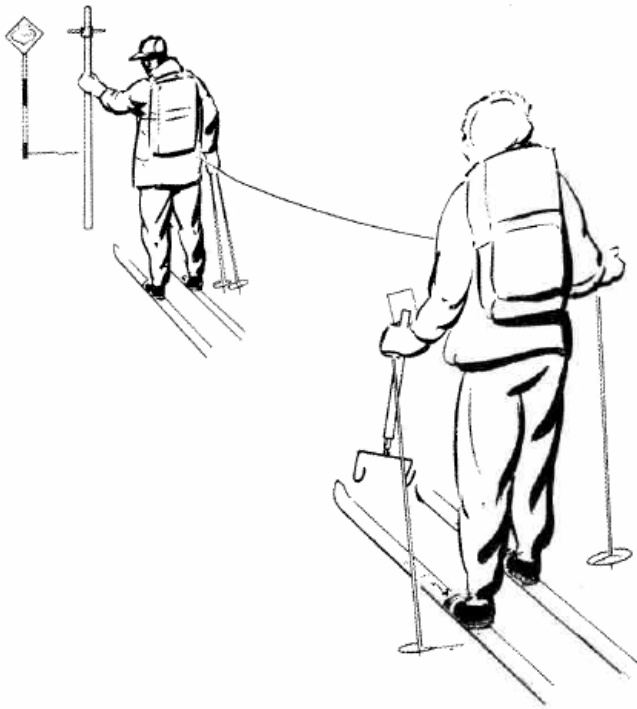

Step 4

If there is no marker at sampling point No. 1, find the point by measuring the correct distance from the snow course end marker, following directions shown on the snow course map.

One surveyor should carry the sampling tube and headend of tape. The second surveyor should carry the scale and notebook and hold the rear end of the tape. The second surveyor sights the first surveyor on line of the course with the next marker.



Step 5

Before taking a sample, look through the tube to check for cleanliness. Hold the sampling tube away from your eye, cutter end up.



Step 6

Hold the sampling tube vertically (cutter end down) and drive it to the ground surface. Wear gloves to keep the tube cool and to make sampling easier. Be sure the cutter penetrates to the ground surface.



Step 7

Before raising the tube, read the depth of snow to the nearest one-half inch. Record the reading.



Step 8

Turn tube at least one turn to right to cut core loose from earth. Carefully raise tube, look through slots, and read core length to the nearest one-half inch.

Call reading to the recorder.

Raise tube carefully out of snow.

Note: Core length should be at least 90 percent of the snow depth except in snow of very low density or mushy snow. If it isn't, retake the sample or explain any deviation under "Remarks."

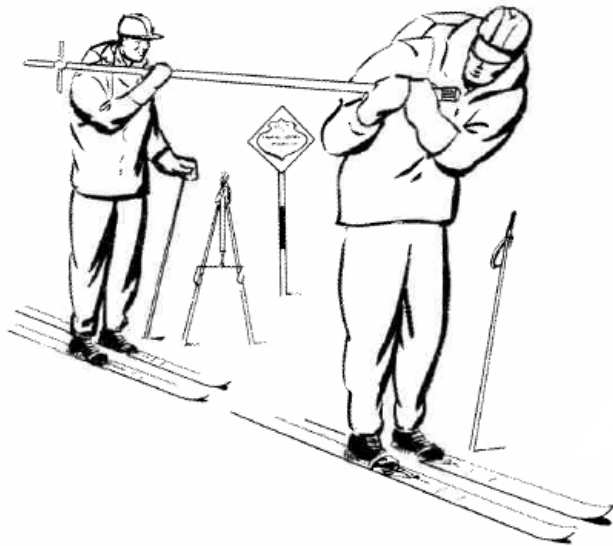

Step 9

Inspect cutter end of tube for dirt or litter.

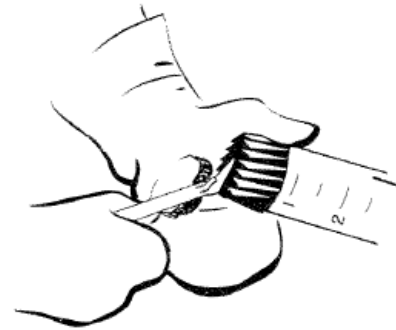

Step 10

With gloves on, use a knife, can opener, or other tool to carefully remove soil and litter from the cutter and tube. Throw the debris or litter several feet (15 feet or more) away from sampling point. This prevents the formation of melt holes at the sampling point.

Correct the reading for snow depth and core length by subtracting the distance driven into soil or litter.

UNITED STATES DEPARTMENT OF AGRICULTURE
SOIL CONSERVATION SERVICE

SCS-EN-708
12-79

FEDERAL-STATE-PRIVATE
COOPERATIVE SNOW SURVEYS

Snow Course Blizzard Ridge
Drainage Basin Missouri-Gallatin State Montana
Sampler G. Clagett Note Taker P.E. Farnes
Date Feb. 28, 1984 Began 1:00 a.m. Ended _____ p.m.

Sample Number	Depth of Snow Inches	Length of Core Inches	Weight of Tube and Core	Weight of Empty Tube	Water Content Inches	Density Percent	Remarks (See reverse)
1	94	92					GNF Damp

Record data as follows:

Record depth of snow to nearest one-half inch (94 inches, circled above).

If sampling point is bare, record a zero in snow-depth column. Do not move away from sampling point to find a spot with snow.

Record length of core to nearest one-half inch (92 inches).

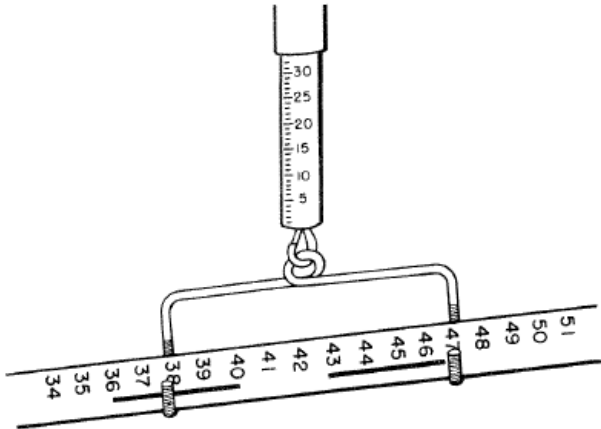

Step 11

Carefully balance the sampling tube containing the core on the weighing cradle.

Never hold the weighing scale with hand around barrel. Suspend it like a pendulum from a ski pole.

If windy, point the tube into the wind.

To ensure an accurate reading, gently tap the scale to be sure it is not sticking or binding.

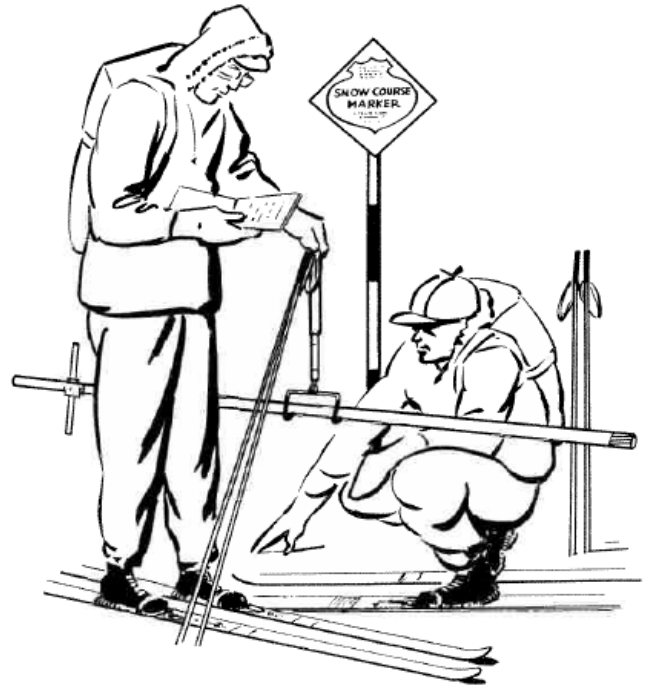

Step 12

Read the weight of tube and core from the graduations on the scale. The scale is marked in inches of water.

Caution: Scales of 12-1/2-foot-tube capacity have graduations equal to 1 inch. Scales of 20-foot-tube capacity have graduations equal to 2 inches.

FEDERAL-STATE-PRIVATE
COOPERATIVE SNOW SURVEYS

Snow Course Blizzard Ridge
 Drainage Basin Missouri-Gallatin State Montana
 Sampler G. Clagett Note Taker P.E. Farnes
 Date Feb. 28, 1984 Began 1:00 p.m. Ended _____ a.m.
 _____ p.m.

Sample Number	Depth of Snow Inches	Length of Core Inches	Weight of Tube and Core	Weight of Empty Tube	Water Content Inches	Density Percent	Remarks (See reverse)
1	94	92	62 1/2				GNF Damp

Step 13

Record the weight of the tube and core to the nearest one-half inch (62-1/2 inches) when using scales for 12-1/2-foot tubes and to the nearest inch when using scales for 20-foot tubes.

When the primary snowpack area of a watershed normally contains snow of low water content or very low density, or both, it is desirable to read the 12-1/2-foot scale to the nearest one-tenth inch.

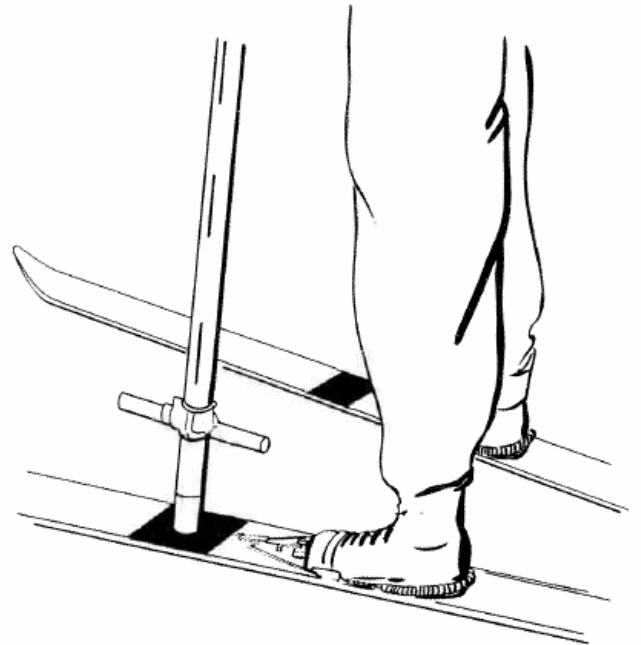

Step 14

Lift the tube from the cradle and turn cutter end up. Tap the tube against a rubber pad on the ski or snowshoe to remove the snow core. Inspect the inside to see that all snow has been removed.

Note: A well-siliconed or waxed tube helps in removing the core.

FEDERAL-STATE-PRIVATE
COOPERATIVE SNOW SURVEYS

Snow Course Blizzard Ridge
 Drainage Basin Missouri-Gallatin State Montana
 Sampler G. Clagett Note Taker P.E. Farnes
 Date Feb. 28, 1984 Began 1:00 p.m. Ended _____ a.m.
 _____ p.m.

Sample Number	Depth of Snow inches	Length of Core inches	Weight of Tube and Core	Weight of Empty Tube	Water Content inches	Density Percent	Remarks (See reverse)
1	94	92	62 1/2	(35)	(27 1/2)		GNF Damp



Step 15

Weigh the empty sampling tube. The weight of the empty tube must read greater than zero on the scale. If using a driving wrench, be sure to leave it attached when weighing the empty tube and when weighing the tube and core of snow.

Step 16

Record the weight of the empty tube to the nearest one-half inch or one-tenth inch for 12-1/2-foot tubes and to the nearest 1 inch for 20-foot tubes.

Check weight of the empty tube at least every fifth sample because small particles of water or snow often cling to the inside and outside of the tube. Checking helps make the sampling more accurate.

Whenever sections of tube are put on or taken off during the sampling, obtain a new empty weight.

Step 17

Subtract the weight of the empty tube from the weight of the tube and core to obtain the water content.

FEDERAL-STATE-PRIVATE
COOPERATIVE SNOW SURVEYS

Snow Course Blizzard Ridge
 Drainage Basin Missouri-Gallatin State Montana
 Sampler G. Clagett Note Taker P.E. Farnes
 Date Feb. 28, 1984 Began 1:00 p.m. Ended _____ a.m.
 _____ p.m.

Sample Number	Depth of Snow Inches	Length of Core Inches	Weight of Tube and Core	Weight of Empty Tube	Water Content Inches	Density Percent	Remarks (See reverse)
1	94	92	62½	35	27½	(29)	GNE Damp

Step 18

To obtain the density, divide the water content by the depth of snow or use the density determination chart on page 21. Record density to nearest whole percent.

Ordinarily, density of individual samples should not vary more than 3 percent unless site conditions are not uniform. If the difference is more than 5 percent, take another sample.

If density varies because of ponded water, differential snowmelt, brush, and the like, note cause under "Remarks."

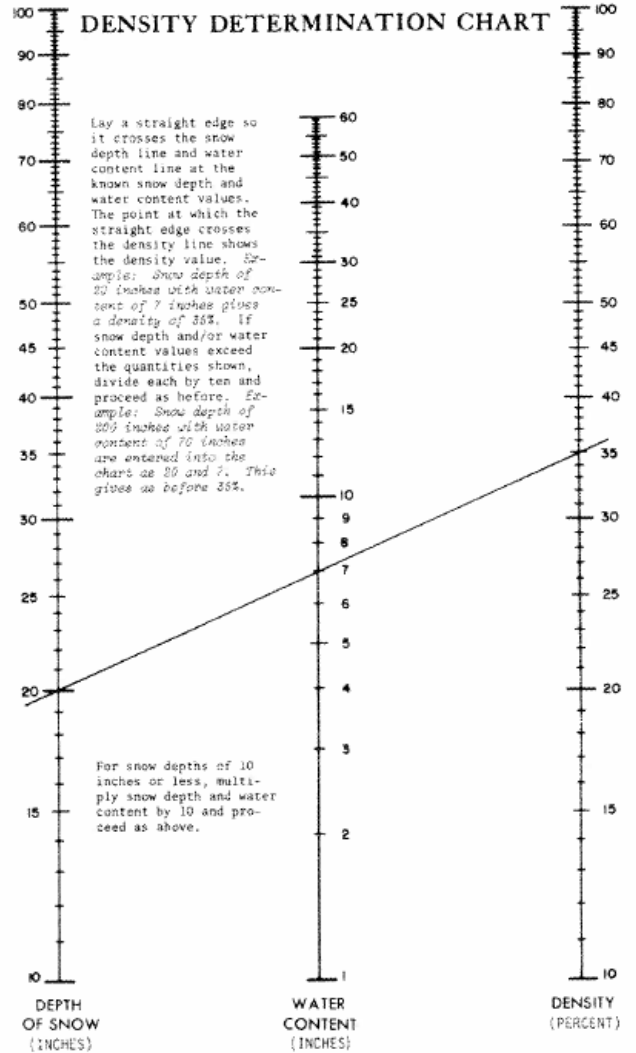

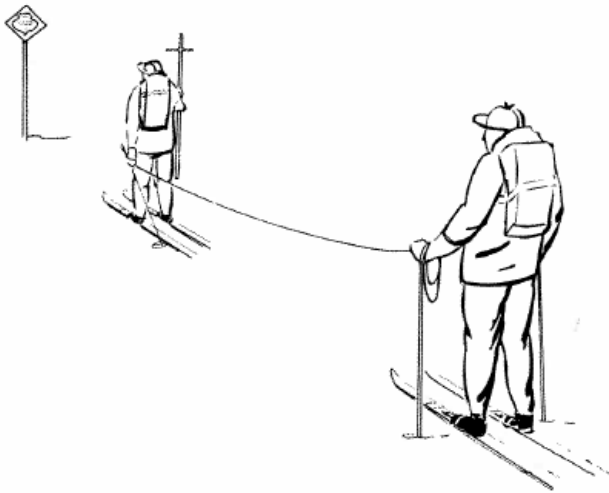

Step 19

Measure and sample the remaining points shown on the snow course map.



Step 20

Before leaving the snow course, both surveyors must inspect the notes. Add the figures in the depth-of-snow column and divide the total by the number of sampling points to get the average depth. Add the figures in the water-content column and divide the total by the number of sampling points to obtain the average water content to the nearest tenth of an inch.

Note: The number of sampling points includes those with zero depth. See completed set of notes on pages 24 and 25. Fill in checklist on back of field notes, adding comments about other conditions.

FEDERAL-STATE-PRIVATE
COOPERATIVE SNOW SURVEYS

Snow Course Blizzard Ridge
Drainage Basin Missouri-Gallatin State Montana
Sampler G. Clagett Note Taker P.E. Farnes
Date Feb. 28, 1984 Began 1:00 p.m. Ended 2:35 p.m.

Sample Number	Depth of Snow Inches	Length of Core Inches	Weight of Tube and Core	Weight of Empty Tube	Water Content Inches	Density Percent	Remarks (See reverse)
1	94	92	62½	35	27½	29	GNF Damp
2	91	89	62		27	30	
3	92	86	62		27	29	
4	85½	79	60½		25½	30	
5	87	82½	60½	35	25½	29	Dry Soil
6	87	82	61½		26½	30	
7	83½	79	59		24	29	
8	84½	81½	60		25	30	Needles
9	85	76	80½	56	24½	29	
10	79½	71½	78½	56	22½	28	2 samples
⑩	86.9				25.5	29	Total
⑩	86.9				25.5		Average

No. of tube sections used, 4
Was driving wrench used? yes, on samples 9 and 10.
No. 1 of 1 sheets. Comp. by P.E.F. Checked by G.C.

NOTE. - Please fill in while in the field.

SAMPLING CONDITIONS

(Please check items descriptive of present conditions)

Weather at Time of Sampling

Clear, Partly cloudy, Overcast, Rain
 Snowing, Blowing, Freezing, Thawing

Snow Conditions at Snow Course

Snow samples obtained with ease, moderate difficulty

Snow samples obtained with extreme difficulty.*

Ground under snow: frozen, not frozen

dry, damp, wet (saturated)

Ice layer on ground None How thick? inches.

How many inches of new snow at snow course? 17 inches

Depth to first snow crust 17 inches.

Are there ice layers in snow pack? Yes No

If yes, show depth from surface inches

General Conditions

Snow on ground at Hdqtrs. office 4 inches.

Name and Location of Hdqtrs. office State office,

Bozeman, MT

Air temperature (if known)

If at aerial marker, record snow depth inches

*Explain fully under remarks

PRECIPITATION DATA

Month	Day	Year	Precipitation	Readings	Reading Made by (check)	Dipstick	Wei
			Current				
			Previous				
Station name			Catch, inches	Scale adjusted to zero			
			After recharge	Yes <input type="checkbox"/> No <input type="checkbox"/>			

Remarks: Heavy crust down 45-50 inc.

Snowshoed last half mile to Course.

For special conditions

Snow freezing in tube

If snow melts and freezes in the point of the sampler and the entire core does not enter the tube, it is probably because the tube is above freezing temperature and the snow below freezing. The following steps can help you meet this difficulty:

1. Cool the tube by setting it in the shade or burying it in the snow.
2. Clean the tube thoroughly, then push it rapidly through the snow without stopping until you reach ground surface.
3. Take samples in the early morning or evening when it is cool.

If these precautions do not help, follow these steps:

1. Thrust the tube as deeply as possible without stopping.
2. Remove the tube carefully so as not to disturb the hole.
3. Record the core length and weight.
4. Empty the tube and return it carefully to the bottom of the hole.
5. Again thrust the tube deeper into the snow until it stops or reaches the ground.

6. Repeat as many times as necessary to reach the ground.

Record data as shown on sample note, page 31.

Sampling very shallow snow

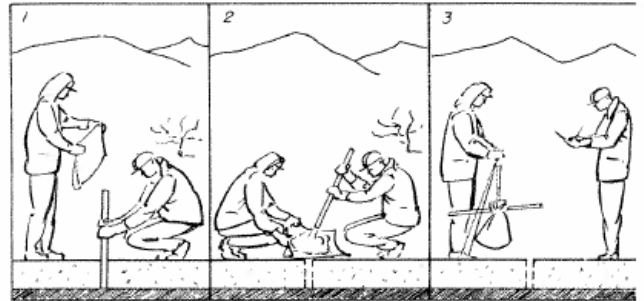

If water content of the snow is less than 2 inches, it is difficult to read the weighing scale accurately for single sampling points. Do as follows:

1. Take a sample at the sampling point.
2. Empty the core into a bucket or any container that can be tied to the weight scale. (If the empty container is not heavy enough to record an empty weight on the scale, add more weight. Use sections of sampling tubes, driving wrenches, or anything handy.)
3. Record the depth of snow and length of core as shown on sample note on the next page.
4. Weigh container and any added weights when all the sample cores have been accumulated.

5. Record this weight in the bottom of the column "Weight of Tube and Core."
6. Empty snow from container. Weigh container and weights and record this figure at the bottom of the column "Weight of Empty Tube."
7. Subtract weight of empty container from weight of container and core. Record the difference at the bottom of the column "Water Content Inches." To obtain average water content on the snow course, divide total water content by total number of sampling points.
8. Total the snow depths and divide by number of sampling points to get average snow depth.

UNITED STATES DEPARTMENT OF AGRICULTURE
SOIL CONSERVATION SERVICE
FEDERAL-STATE-PRIVATE
COOPERATIVE SNOW SURVEYS

Snow Course Suicide Park
 Drainage Basin Gila State Arizona
 Sampler G. Watt Note Taker D. Enz
 Date Feb. 15, 1984 Began 11:00 A.M. Ended 11:30 P.M.

Sample Number	Depth of Snow Inches	Length of Core Inches	Weight of Tube and Core	Weight of Empty Tube	Water Content Inches	Density Percent	Remarks (See reverse)
1	2	2					Dry
2	2 1/2	2					
3	6	5					
4	3 1/2	3					G D F
5	2	2					
6	6	5 1/2					
7	8 1/2	7					G D F
8	2	2					
9	3 1/2	2 1/2					
10	5	4 1/2					
	//						
(10)	41		30.5	18	12.5	30	Total
10	4.1				1.3		Average

Tubes too short for depth of snow

WHEN SNOW DEPTH IS A FEW INCHES MORE THAN LENGTH OF SAMPLERS

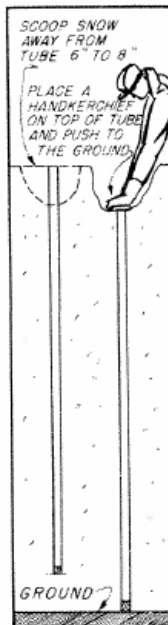

WHEN SNOW DEPTH IS CONSIDERABLY GREATER THAN LENGTH OF SAMPLERS.

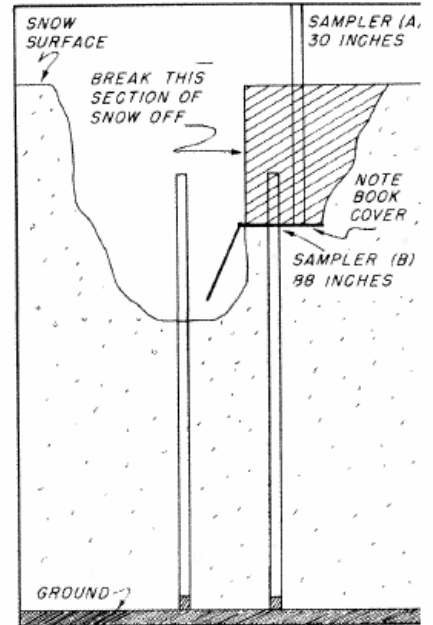

If the depth of snow is greater than the length of tubing at hand, do the following:

1. Drive the tube its full length into the snow.
2. Place a handkerchief or similar object over the top of the tube.
3. Dig down around the tube to a depth of about 1 foot.
4. Stand on tube and force it down farther.

- Remove the wadding and observe the depth of the core. When the core reaches the top of the tube, you have reached the limit for this method of measurement.

The depth of the snow is the distance from the snow surface to the top of the tube added to the length of the tube.

If the snow is too deep to get a whole sample by this method, then do the following:

- Dig a hole in the snow at the sampling point to a depth of 2 to 3 feet. Try sampler in bottom of hole. If you have not reached the ground surface, dig deeper. Use ski heel or tip of snow-shoe for a shovel if nothing else is available.
- Slide a metal plate or firm, flat object (aluminum notebook cover) into side of pit at a depth below the top of the grounded sampler.
- Drive sampler down to metal plate.
- Measure snow depth and core length of the first section of snowpack.
- Break off snow into pit down to metal plate.
- Weigh and record weight of tube and core and weight of empty tube. (See p. 31.)
- Sample from metal plate down to the ground surface. Weigh and add depths and water contents for that sampling point. (See p. 31.)
- Be sure to fill the hole if the course is to be sampled at a later date. Make a note to bring additional sections of sampler tubing for future surveys.

FEDERAL-STATE-PRIVATE
COOPERATIVE SNOW SURVEYS

Snow Course Dead Man Creek
Drainage Basin Columbia-Willamette State Oregon
Sampler T. George Note Taker M. Vance
Date Apr. 1, 1984 Began 11:00 a.m. Ended a.m.
p.m.

Sample Number	Depth of Snow Inches	Length of Core Inches	Weight of Tube and Core	Weight of Empty Tube	Water Content Inches	Density Percent	Remarks (See reverse)
1a	30	29	31½	19	18½	42	Tube too short Damp
1b	88	88	58	19	39½	45	
1	118	117			52	44	←
2a	38	36	34	19	15	39	GNF
2b	86	85	55	19	36	42	Wet
2	124	121			51	41	←
3a	22	20	28	19	9	41	GNF
3b	89	88	57	19	38	43	Grass Damp
3	111	108			47	42	

Example of note keeping for samples taken in sections.

Totals are found by adding figures in rows 1, 2, 3, etc.

No. of tube sections used, 3
Was driving wrench used? Yes
No. 1 of 3 sheets. Comp. by M. V. Checked by T. G.

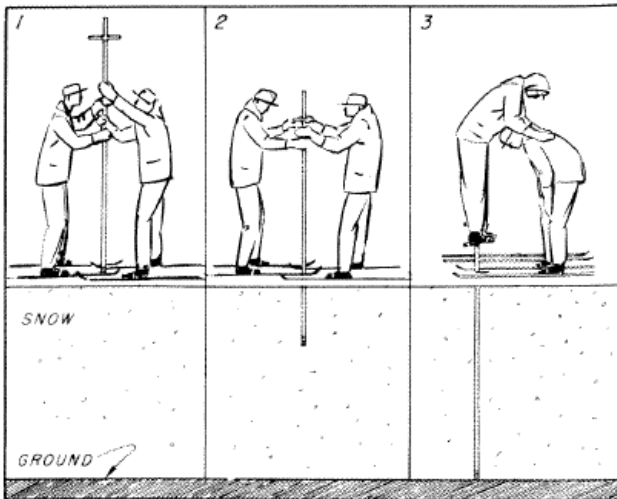

Notes

Driving sampler through layers of deep snow

When sampling deep snow, drive the sampler rapidly. Keep it moving continuously until the ground surface is reached.

The following procedure is suggested:

1. Both surveyors drive the sampler with a hand-over-hand motion, keeping the sampler in motion.
2. Grab the driving wrench handle and push down.
3. If the tube stops, one surveyor steps on the handles and drives the tube down to the ground surface with a pumping action of the knees while balancing against his partner's shoulders.

This Guide was written by the Water Supply Forecasting Unit, West National Technical Center, and state snow survey supervisors of the Soil Conservation Service in the West, in consultation with other snow surveyors and equipment manufacturers.