

**Computers Applied to the Management
of Large-Scale Agricultural
Enterprises:**

**Papers and Proceedings of a
U.S.-U.S.S.R. Seminar, Moscow,
Riga, Kishinev
1976**

GOSSYM: A SIMULATOR OF COTTON CROP DYNAMICS

D. N. Baker,* J. R. Lambert,** C. J. Phene, J. M. McKinion

INTRODUCTION

My remarks here will supplement and extend those of Dr. Lambert to the simulation of the whole crop system and to applications for such models. We are outlining a new technology in crop production research. It is appropriate to do this at this point in time because of the alarming rise in the cost of food and the matching imbalance between world food supplies and population. There are the starving millions now, and many forecasts suggest that specter awaits many more people in many more countries.

Today we are faced with a two-pronged dilemma. On one hand, we have incredibly complex technical problems demanding solution. On the other hand, we have an information explosion. Scientists often have little, if any, basis on which to judge the economic and social value of their experiments. For example, it can be stated fairly that most scientists doing basic research in photosynthesis (an area with which I happen to be familiar) have no clear and detailed picture of the part their work might play in increasing crop yields or even how photosynthesis relates to the other processes in the plant. This is not to suggest that yields are not determined in some instances by rates of photosynthesis, or that basic research is unnecessary. It is suggested, rather, that at a given point in time some experiments are more likely to contribute to understanding of the system than others. This paper and that of Dr. Lambert outline a methodology for identifying and evaluating those research areas. It serves as a medium of communication and contributes to a natural consensus among scientists as to goals and

* Boll Weevil Research Lab, Mississippi State College
** Dept. of Agricultural Engineering, Clemson University

priorities. We believe that this is an appropriate moment in history for the introduction of a new (computer based) technology for the synthesis of scientific information into a coherent format for use by the scientist, the research administrator, and the farm manager.

The feasibility of building simulation models of plant growth and yield has recently been demonstrated, and models of cotton, corn, alfalfa, soybeans, peanuts, sugar beets, wheat, and sorghum are now available. Such models have been developed at research locations in the U. S., England, Australia, and the Netherlands. They have in common the fact that they are dynamic materials balances. This work may be viewed as a natural extension of the growth analysis work in England beginning with Fisher⁷ and Gregory⁸ and the later work of Watson²¹, and, in the USSR, the work of Nichiporovich.¹⁷ The experimental research in crop canopy photosynthesis of Musgrave and his students in the U. S.^{15, 3} and that of Murata¹⁶ and others in Japan, as well as the static modeling of crop canopy photosynthesis by Monsi and Saeki⁴ in Japan, Duncan⁶ in the U. S., de Wit⁵ in the Netherlands and Ross¹⁸, Tooming¹⁹, and others in the USSR immediately precede our dynamic modeling work in the effort to predict growth and yield of field crops.

THEORY

Dr. Lambert has already outlined our work in the soil processes. The whole system model I will discuss is called GOSSYM and incorporates RHIZOS. RHIZOS provides the remainder of GOSSYM with three parameters; an effective soil water potential which is used to calculate plant water potential, an estimate of metabolite sink strength in the roots, and a nitrogen uptake rate.

GOSSYM, like most dynamic simulators of plant growth, is a materials balance. The concept is presented in figure 1. Here, standard systems dynamics notation is used: rectangles represent pools of material of definite size; pools of indefinite size are represented by the irregular enclosures; the valve-shaped characters represent regulators of the rates of flow between pools; solid lines represent material flows; and dashed lines (to the flow valves) represent information flow. The plant model contains pools of nitrogen and labile carbohydrates which arrive via the transpiration stream and the photosynthetic processes respectively. These materials flow (through growth) to the leaves, stems, fruit, and roots. Various losses occur as a result of insect damage and the natural plant processes, senescence and abscission, in response to physiological stress. The model depicts the redistribution (mining) of nitrogen within the plant. The initiation of organs on the plant (not depicted in the figure) occurs as a series of discrete events, with rates depending on temperature and the physiological status of the plant. Each day the plant is diagrammed as in figure 2.

GOSSYM is arranged by subroutine as shown in figure 3. The RHIZOS subroutines are in the upper right of the figure called by, and including, CLYMAT and SOIL. In CLYMAT canopy light interception is calculated from plant height (Z) and row spacing (ROWSP) as shown in equation (1).

$$\text{INT} = 1.0756 * Z / \text{ROWSP} \quad (1)$$

This expression summarizes accurately a large volume of empirical data collected in intact cotton crops.²

After SOIL, PNET is called. This important subroutine is shown in its entirety in table 1. In lines 10-17 a factor (PTSRED) for reducing

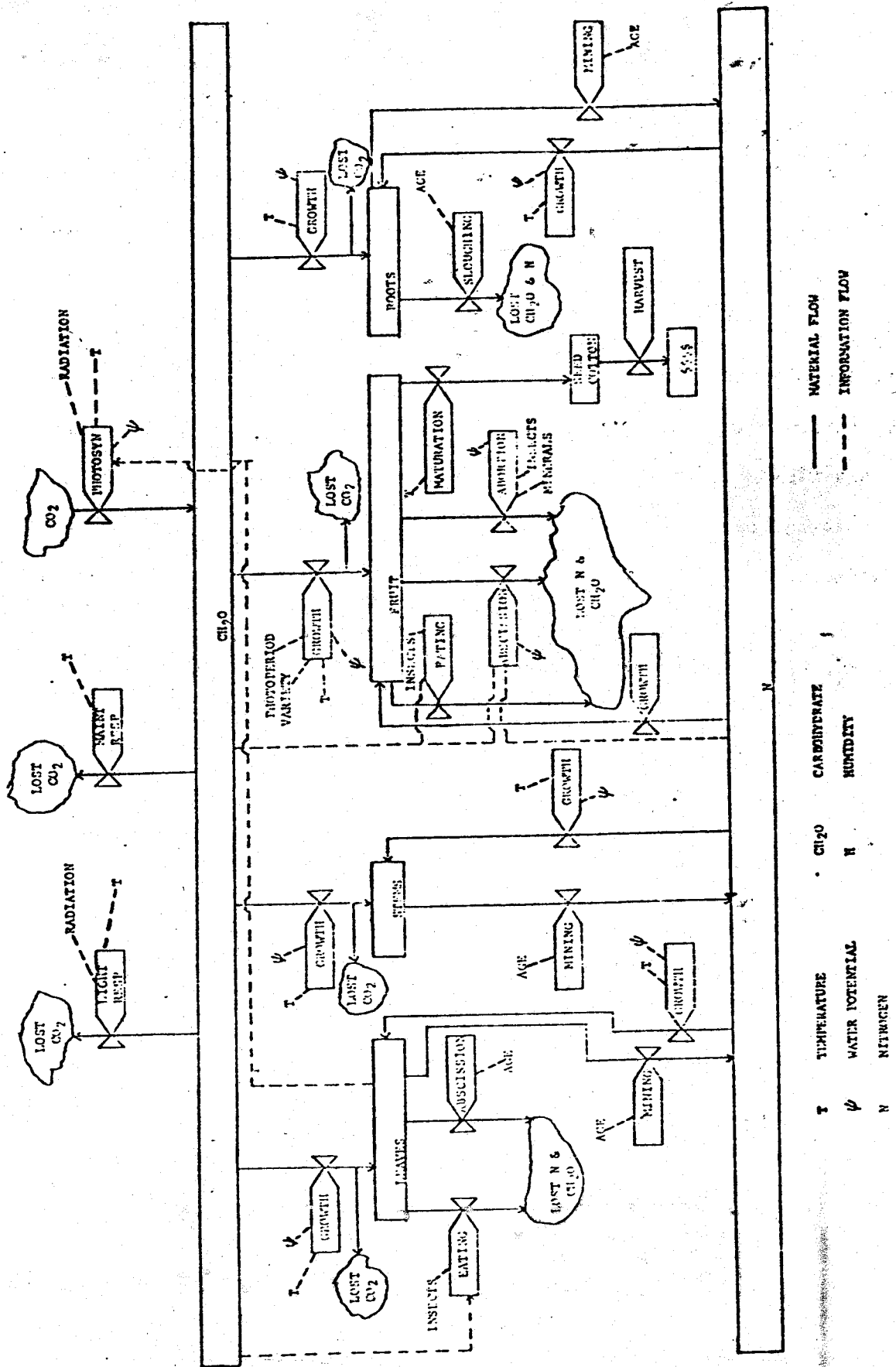

Figure 1.--A conceptual model of the growth of cotton.

```

      I-X
    X-I
      I-0-X
  X-0-I
      I-0-0-X
X-0-0-I
      I-0-0-0-X
X-0-0-0-I
      I-0-0-0-0-X
X-0-0-0-0-I
      I-0-0-0-0-0-X
X-0-0-0-0*-I
      I-0-0-0-0-0-0
X-0-0-0*-0-I
      I-0-0-0-0-0-X
      I
      I
      I
      I
      I
      I

```

```

      I-X
    0-I
      I-0-X
  X-0-I
      I-X-0-0-X
      I
      I

```

Figure 2.--A typical daily map of the fruiting in GOSSYM. "I" and "-" represent mainstem and fruiting branch internodes, respectively. "\$", "*", "0", and "X" represent nodes with open bolls, green bolls, aborted fruit, and squares, respectively. The figure on the right represents a monopodial structure attached to the 5th mainstem node.

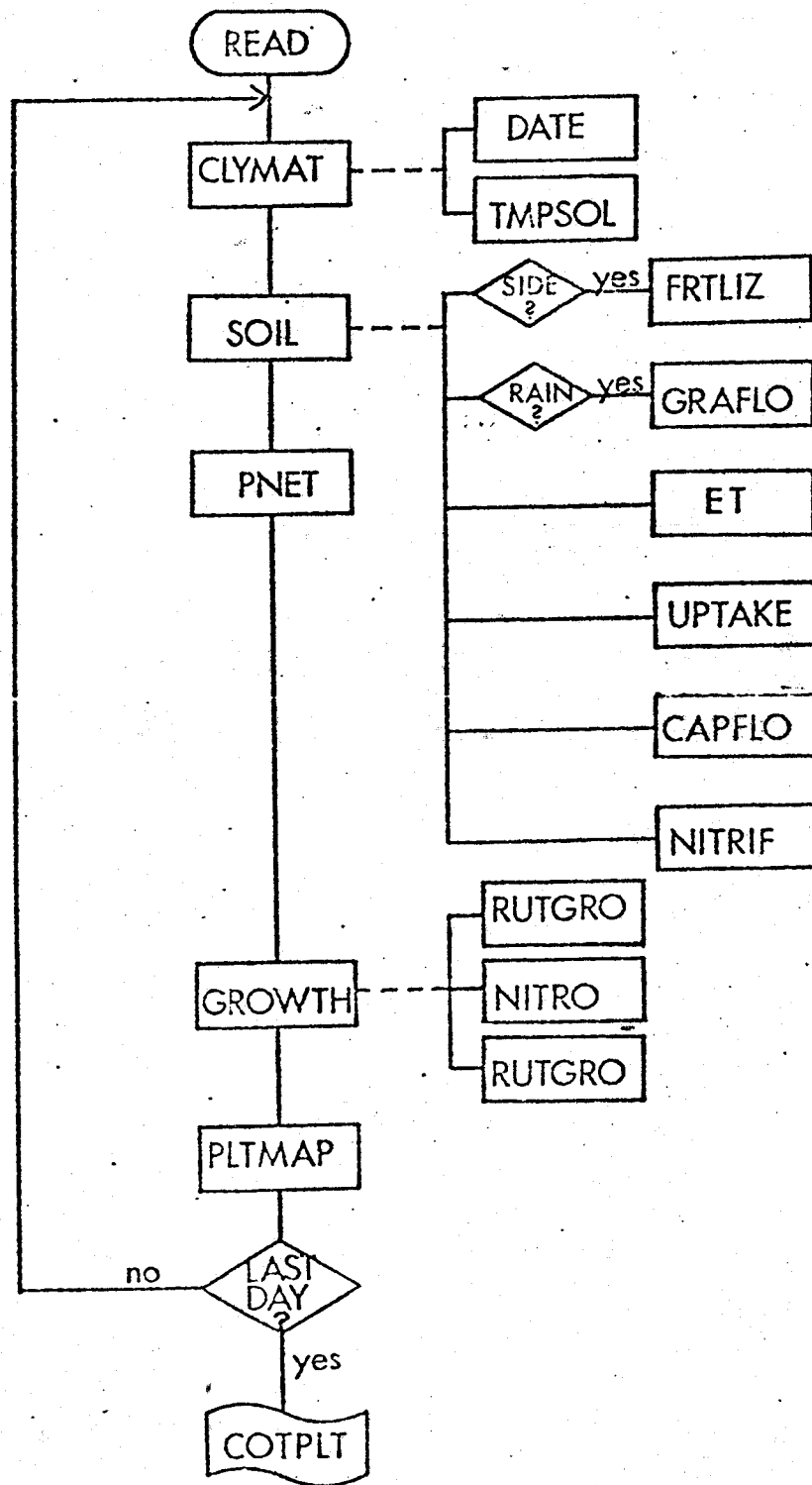

Figure 3.--The subroutine structure of COSSYM.

Table 1. The PNET Subroutine.

```

C *****
C *
C *          PNET SUBROUTINE
C *
C *****
0003     REAL INT,LEAFWT,LYTRES
C
0004     COMMON /POP / PN, POPFAC
0005     COMMON /SOLAR / INT, RI, RN, WATTSM
0006     COMMON /TEMP / TAVG, TDAY, TMAX, TMIN, TNYT
0007     COMMON /WEIGHT/ COTXX, GBOLWT, LEAFWT, PLANTW, ROOTWT, SQWT, STEMWT
0008     COMMON /WETS / POLYNA, PSIAVG, PSIMAX, RAIN
C
0009     DATA CO2/0./, RSUBO/.0032/, GSUBR/.375/
C PSILIN IS AN INDEX PSI(L) AT 0.3 BARS.
C PSIS AND 27 C. - FULLY TURGID
C PINDEX IS AN INDEX NET P RATE (SAME CONDITIONS).
0010     AVGPSI = PSIMAX
C PSIL IS MINIMUM LEAF WATER POTENTIAL FOR THE DAY.
0011     IF (AVGPSI.LT.-1.5) AVGPSI = -1.5
0013     PSIL = -12.63 + 0.01799*WATTSM - 26.1097*AVGPSI -
      . 0.00001553*WATTSM*WATTSM - 18.289*AVGPSI*AVGPSI +
      . 0.025497*WATTSM*AVGPSI
0014     PSILIN = -3.82193 - 0.00333224*WATTSM
0015     PINDEX = -0.101235 + WATTSM*(0.0234135 - WATTSM*0.000017396)
0016     DPN = 0.24*(PSILIN-PSIL)
0017     PTSRED = (PINDEX-DPN)/PINDEX
C DATA LEADING TO THIS PTSRED ARE FROM CHAMBER EXPERIMENTS IN INTACT
C CROP CANOPY (BAKER & HESKETH, UNPUBLISHED 1969).
C PSTAND, RSUBL, RSUBO, GSUBR FROM BAKER ET. AL. (1972)
C SIMULATION OF GROWTH AND YIELD IN COTTON: I. GROSS PHOTOSYNTHESIS,
C RESPIRATION AND GROWTH. CROP SCI. 12: 431-435.
0018     PSTAND = 2.3908 + WATTSM*(1.37379 - WATTSM*0.00054136)
0019     PPLANT=PSTAND*INT*POPFAC*PTSRED*0.001*1.06
C VALUES BASED ON DATA OF HARPER ET. AL. (1973) CARBON DIOXIDE AND
C THE PHOTOSYNTHESIS OF FIELD CROPS. A METERED CARBON DIOXIDE
C RELEASE IN COTTON UNDER FIELD CONDITIONS. AGRON. JOUR. 65: 7-11.
C AND ON BAKER (1965) EFFECTS OF CERTAIN ENVIRONMENTAL FACTORS
C ON NET ASSIMILATION IN COTTON. CROP SCI. 5: 53-56. FIG 5.
0020     IF (CO2.EQ.1)PPLANT=PPLANT*1.405
C CO2 IS A FERTILIZATION TRIGGER. WHEN CO2 IS EQUAL TO 1, PPLANT IS
C INCREASED 20% DUE TO 500 PPM CO2 CONCENTRATION.
0022     RSUBL=0.0032125+0.0066875*TDAY
0023     LYTRES = RSUBL*PPLANT
0024     BMAIN=(PLANTW-COTXX)*RSUBO
0025     PTS=PPLANT-LYTRES-BMAIN
0026     IF(PTS.LE..01)PTS=.01
0028     PN=PTS/(1.GSUBR) * 0.68182
C 0.68182 CONVERTS CO2 TO CH2O
0029     RETURN
0030     END

```

photosynthesis in response to water stress is calculated. This is based on data from closed system gas exchange experiments in field cotton plantings.¹ Line 18 represents a photosynthetic light-response curve for canopy photosynthesis data obtained under ideal conditions.² Line 19 calculates photosynthate production on a single plant basis by adjusting the canopy photosynthesis value (PSTAND) for light interception (INT), plant population (POPFAC), and moisture stress (PTSRED). In lines 22-24 light (LYTRES) and maintenance (BMAIN) respiration losses are calculated. These are subtracted from the photosynthate value (PPLANT), leaving an increment of carbohydrate available for growth. Part of this (GSUBR) is lost in the growth process. PN in line 24, then, represents the day's increment of carbohydrate available for distribution among the growing points in the plant structure.

After BNET, GROWTH calculates potential growth rates of each of the organs on the plant. The data base for these calculations is from phytotron experiments.¹¹ The calculations account for the effect of temperature and tissue turgor on dry matter assimilation rate. A total carbohydrate demand (CD) is calculated as follows:

$$CD = SPDWRD + SPDWRN + PDSTMD + PDSTMN + SPDWLD + \quad (2)$$

$$SPDWLN + TPDWLD + TPDWLN + SPDWSQ + SPDWBO$$

where the terms to the right of the equals sign represent sum of potential changes in weight of: root during daylight hours, root during nighttime hours, stem during daytime, stem during nighttime, branch leaves during daytime, branch leaves during nighttime, main stem leaves during daytime, main stem leaves during nighttime, squares, and bolls, respectively. The

carbohydrate pool (CPOOL) is calculated as the sum of the plant reserves plus the day's net photosynthate production. Then, a stress (CSTRES) term is calculated as in equation (3).

$$\text{CSTRES} = \text{CPOOL}/\text{CD} \quad (3)$$

Next, the various potential growth values are multiplied by CSTRES to get reduced potential growth rates. Then, using very similar logic, NITRO calculates nitrogen stress parameters for the fruit and vegetative parts. This stress is very important since cotton is an indeterminate perennial and, in order to halt its growth and facilitate harvest, it is customarily subjected to a severe nitrogen stress at the end of the season. Ordinarily, some yield is sacrificed in this, and the management decisions are further complicated by the vagaries of the season's weather and insect attacks. On the return to GROWTH, CSTRES is multiplied by the nitrogen stress values to obtain factors for distributing the actual nitrogen and carbohydrate supplies among the various growing points in the plant in proportion to their share of the demand, to obtain factors (used in PLTMAP) to slow the plant morphogenetic development rates, and to serve as an index for the abortion of fruit. In this way, the nutritional status of the crop is evaluated, and growth and fruiting are determined. The time between events for the formation of new nodes and the maturation of fruit are calculated in PLTMAP from temperature and the delays developed in GROWTH. Here, too, the actual initiation and the abscission of fruit occur.

The program performs all of these steps daily and prints out information on plant height, weight, fruit load, nutritional status, and, ultimately, economic yield.

MODEL VALIDA

A comparison of GOSSYM predictions and real world observations of vegetative development in a cotton crop are shown in figure 4. This represents the classic "sigmoid" growth curve observed in most crops. The decreased rate of morphogenesis from day ninety on reflects the action of nutritional stress-induced delays. A similar comparison of predicted and actual fruiting is shown in figure 5. This comparison is made in figure 6 for SIMCOT II, which is a predecessor of GOSSYM. The real world data shown here were obtained by Dr. Russell Bruce.⁴ This was in a crop planted at 50,630 plants/ha in 91 cm rows, fertilized four times during the season at 84 kg/ha N, and irrigated whenever soil suction in the root zone fell below -0.4 bar. So, this crop suffered no water or nitrogen stress.

A more practical validation of SIMCOT II is shown in figure 7 for a commercial planting.¹² Here, the plant population was 101,270 plants/ha, and the crop was fertilized at planting with 22 kg/ha N and side-dressed at 75 kg/ha N. It yielded 4.15 bales/ha seed cotton. The lines in the figure represent the real crop observations, and the squares and asterisks represent the model predictions of square and boll counts, respectively.

It should be noted that in order to simulate squaring and flowering as well as shown here, all of the important plant processes must be simulated, or at least accounted for, properly and coordinated correctly. Otherwise, the inflections of these curves will be incorrect in location and in degree of curvature. The quality of these simulations suggests then that these models are essentially correct in structure, and there

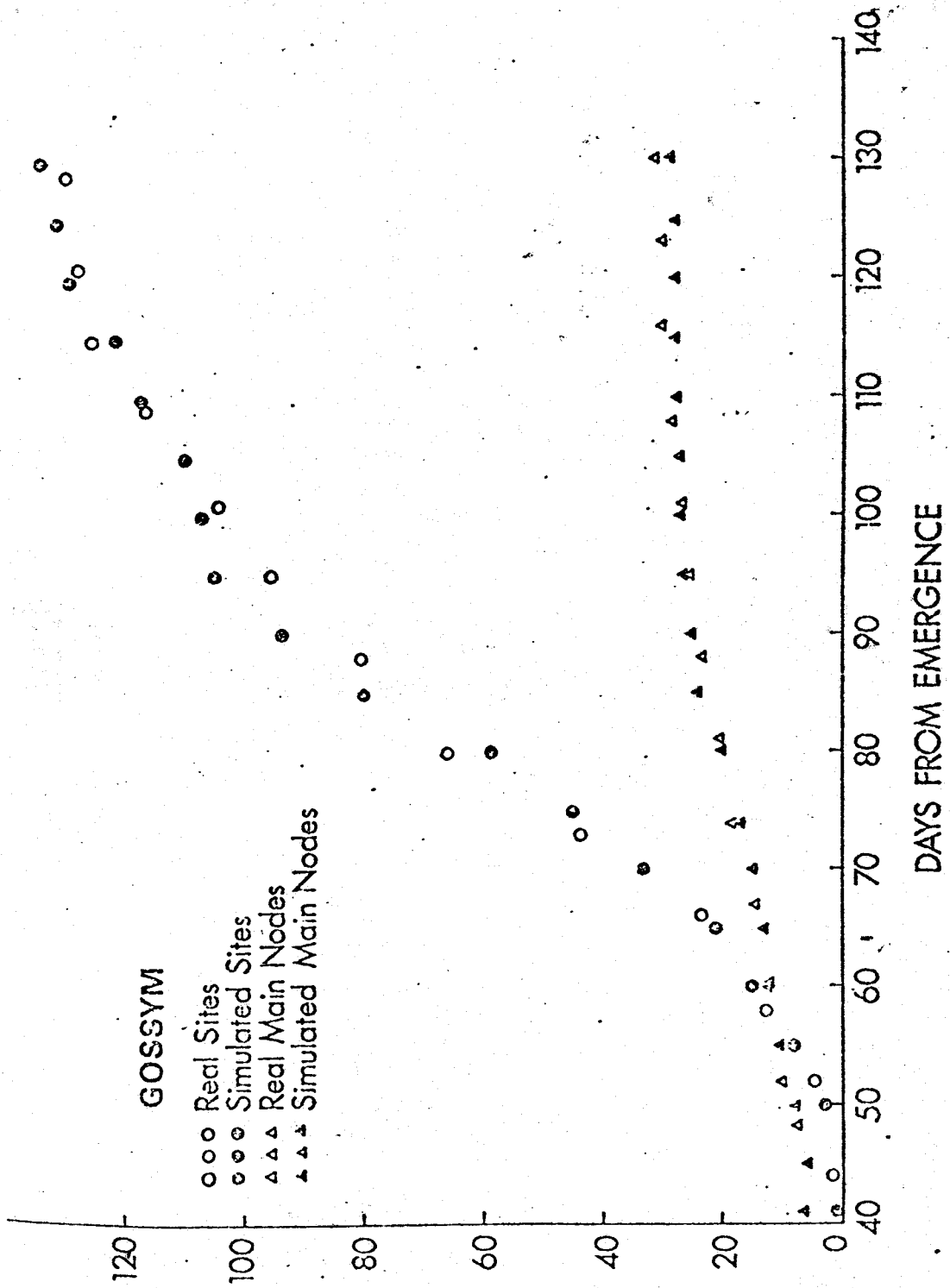

Figure 4.--A comparison of the seasonal development of mainstem nodes and fruiting sites (on a per plant basis) in GOSSYM with observations of Bruce and Römken (4).

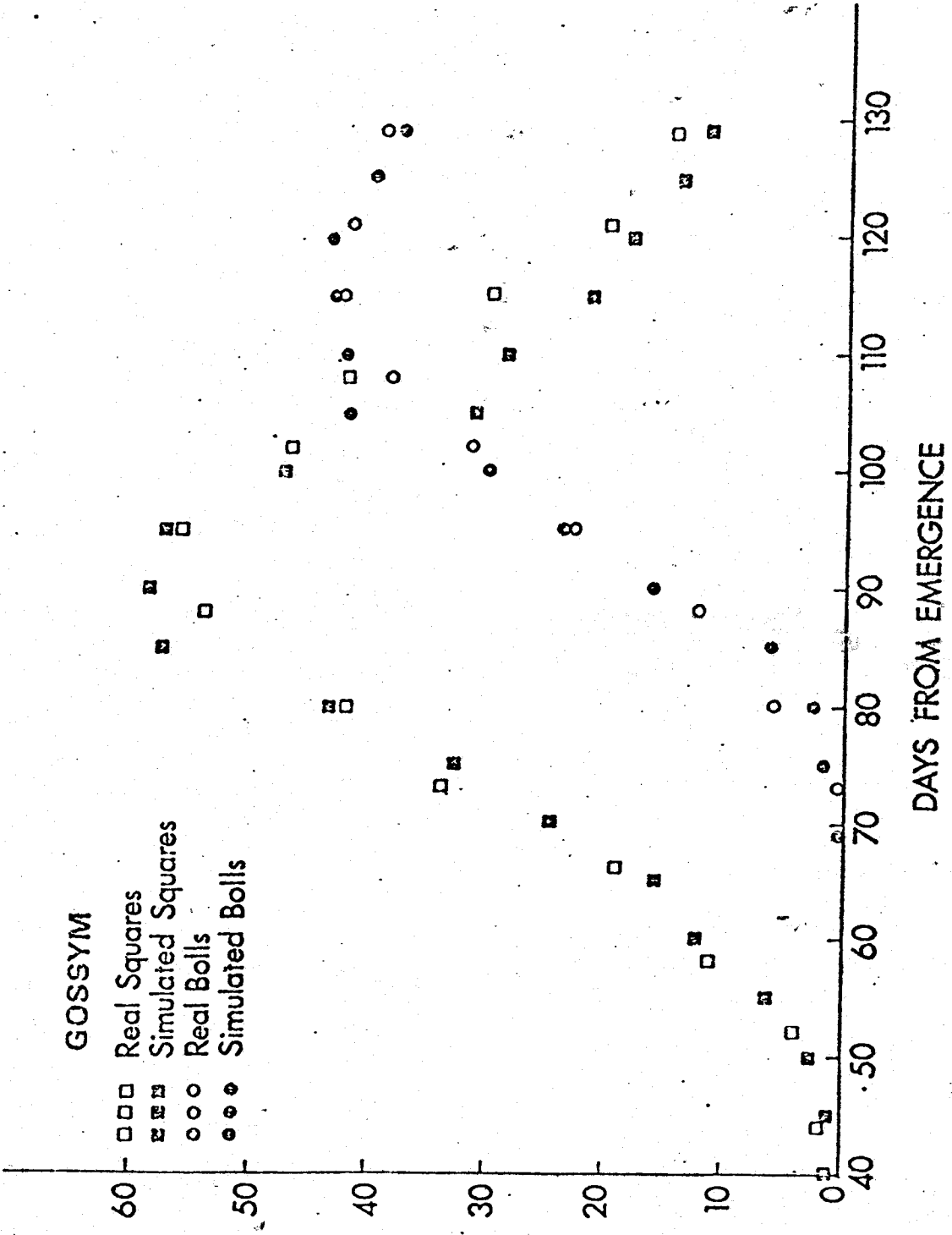

Figure 5.--A comparison of the seasonal development of squares and bolls (on a per plant basis) in GOSSYM with observations of Bruce and Römken's (5).

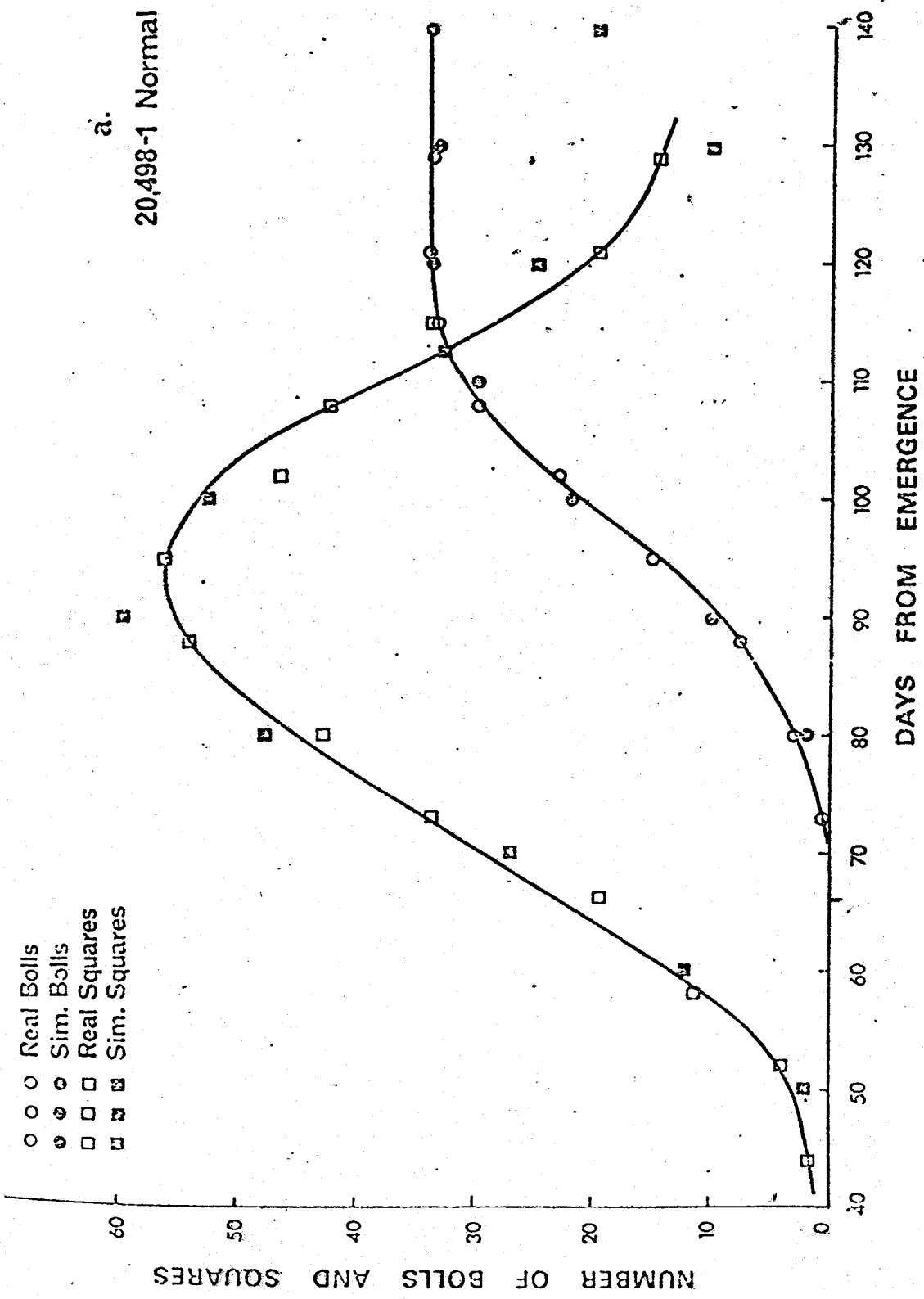

Figure 6.--A comparison of the seasonal development of squares and bolls (on a per plant basis) in SIMCOT II with observations of Bruce and Rbmkens (5).

is increasing evidence that the theory of growth and morphogenesis laid out in GOSSYM can be generalized to all crops.

APPLICATIONS

One of the first applications we made of SIMCOT II was to examine the probable effects of changes in photosynthetic efficiency, which could be done simply by multiplying each day's increment of photosynthate by a factor. We felt that, although the soil water-nitrogen sections of the model were crude, we would be safe using the inputs to Bruce's experiment, where there were no water or nitrogen stresses. Table 2 shows the standard run on the left and runs with relative photosynthetic efficiencies of 0.5 and 1.5, respectively, in the middle and on the right. The first boll appeared on day 72, and the stress became progressively more severe until about day 115 when the first bolls began to open, allowing the stress to relax. One can also see the accompanying pattern of abscission. Again, note that this matches Bruce's plant map data. Cutting photosynthate supply in half produced much more severe stress and the abscission of squares began and peaked earlier. The reverse was true with a fifty percent increase in photosynthate production, with notable effects on plant weights and yields. The trends exhibited in this exercise are particularly interesting. A series of computer "runs" of this type were made, and a relation between predicted yield and relative photosynthetic efficiency is shown in figure 8. This forecast yield response represents the case where abundant water and nitrogen are supplied and perfect insect control is achieved. Such a prediction is very difficult to obtain via traditional research methods. It could, however, be very useful in evaluating the potential benefits of photosynthesis research.

100 COUNTRIES
 X TOTAL BELLS
 100% POP 1000 1.0 29. 67 0 1.08 YIELD

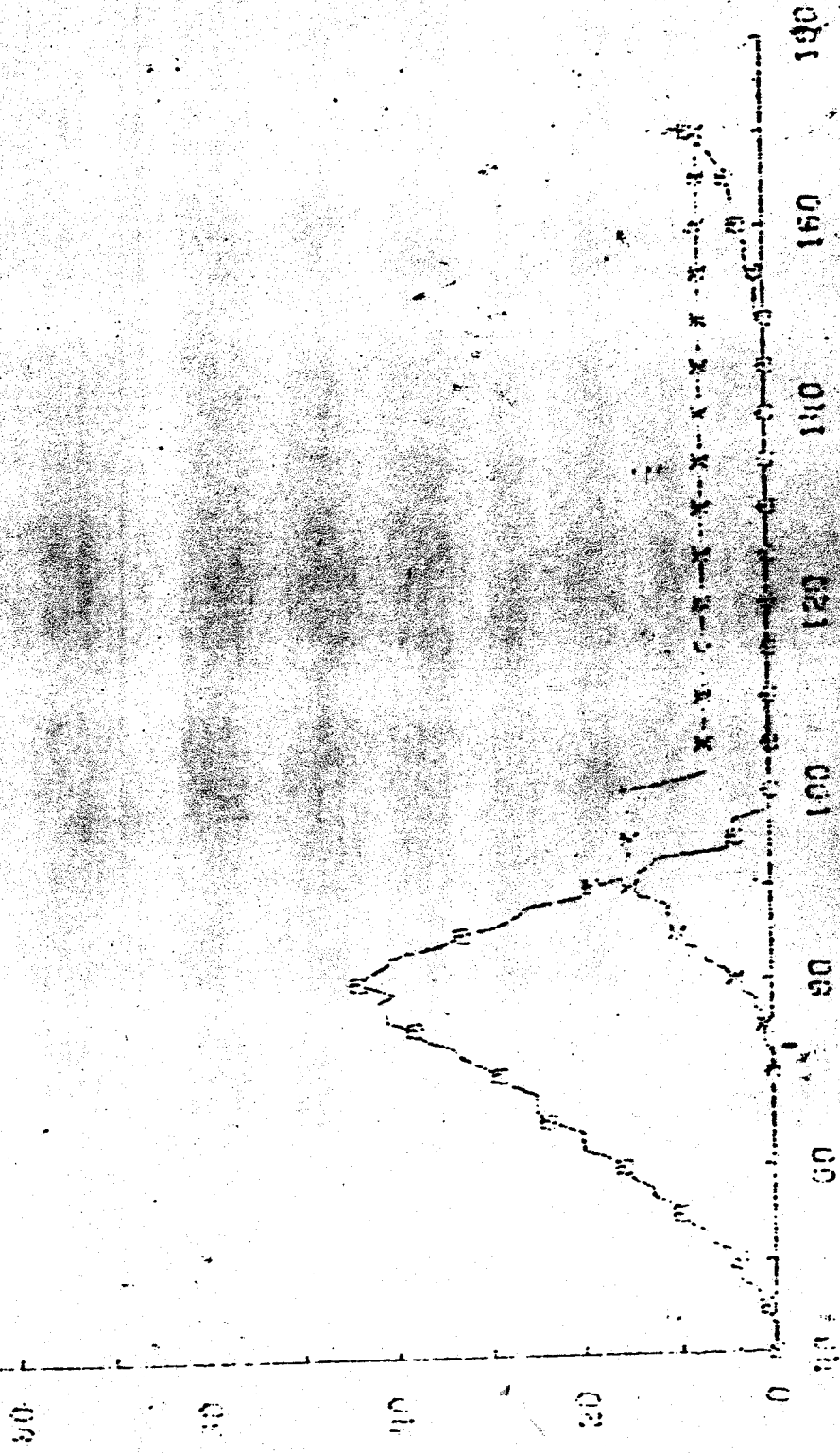

DAYS FROM EMERGENCE

FIGURE 7.--A comparison of the seasonal development of squares and bolls (on a per plant basis) in SINCOT II with observations on a commercial crop by Jenkins (12). Solid lines represent the real crop data. Characters represent SINCOT II predictions.

Table 2. Model predictions of the time course physiological CSTRES development and fruit abscission in cotton with varying photosynthetic efficiencies.

Day from emergence	Relative P. eff. = 1		Relative P. eff. = .5		Relative P. eff. = 1.5	
	CSTRES	Abscission	CSTRES	Abscission	CSTRES	Abscission
75 - 79	.93	1	.60	8	1.0	0
80 - 89	.82	9	.49	18	.95	1
90 - 99	.58	26	.33	14	.67	25
100-109	.47	19	.32	3	.51	21
110-119	.40	13	.32	0	.42	16
120-129	.48	11	.47	0	.50	7
130-139	.73	6	.75	0	.76	7
Open bolls/plant		29		15		38
Plant weight		185 g		97 g		252 g
Yield		7.41 bales/ha		2.87 bales/ha		10.42 bales/ha

Applications in farm management are easy to envision.

One cultural change a farmer might make would be to plant narrower rows, leaving the planting rate the same within the row. Figure 9 shows predicted square and boll yields for cotton planted in fifty-one centimeter rows at 101,000 plants/ha. The weather inputs are from the commercial planting mentioned above. Photosynthate production was lower for each plant resulting in an earlier and more severe carbohydrate stress as indicated by the square abscission. The plant weighed thirty-five grams compared with forty-three grams at first bloom, but there is also a smaller amount of nitrogen available to each plant, and nitrogen stress too was more severe, causing the abscission of all but two of the ten bolls set. Yield was depressed. These results are very similar to those observed in field experiments in Mississippi in 1974 with narrow row cotton plantings.

Going the other way, the farmer might widen the rows and reduce his plant population. Figure 10 shows that the carbohydrate stress was less severe--plants weighed fifty-four grams at first bloom compared with forty-three, but still twice as much fertilizer was available, and no bolls were abscised, and a higher yield resulted. This might seem to suggest that plantings should be made at wider row spacings, but a closer inspection of figure 10 reveals that in this low population crop the last boll that opened was not set until day ninety-six, whereas the last boll in the standard crop was set by day eighty-three. This two-week delay in maturity can be very important. Along with harvesting problems, insect pressure often builds tremendously toward the end of the season, especially in a leafy, late crop.

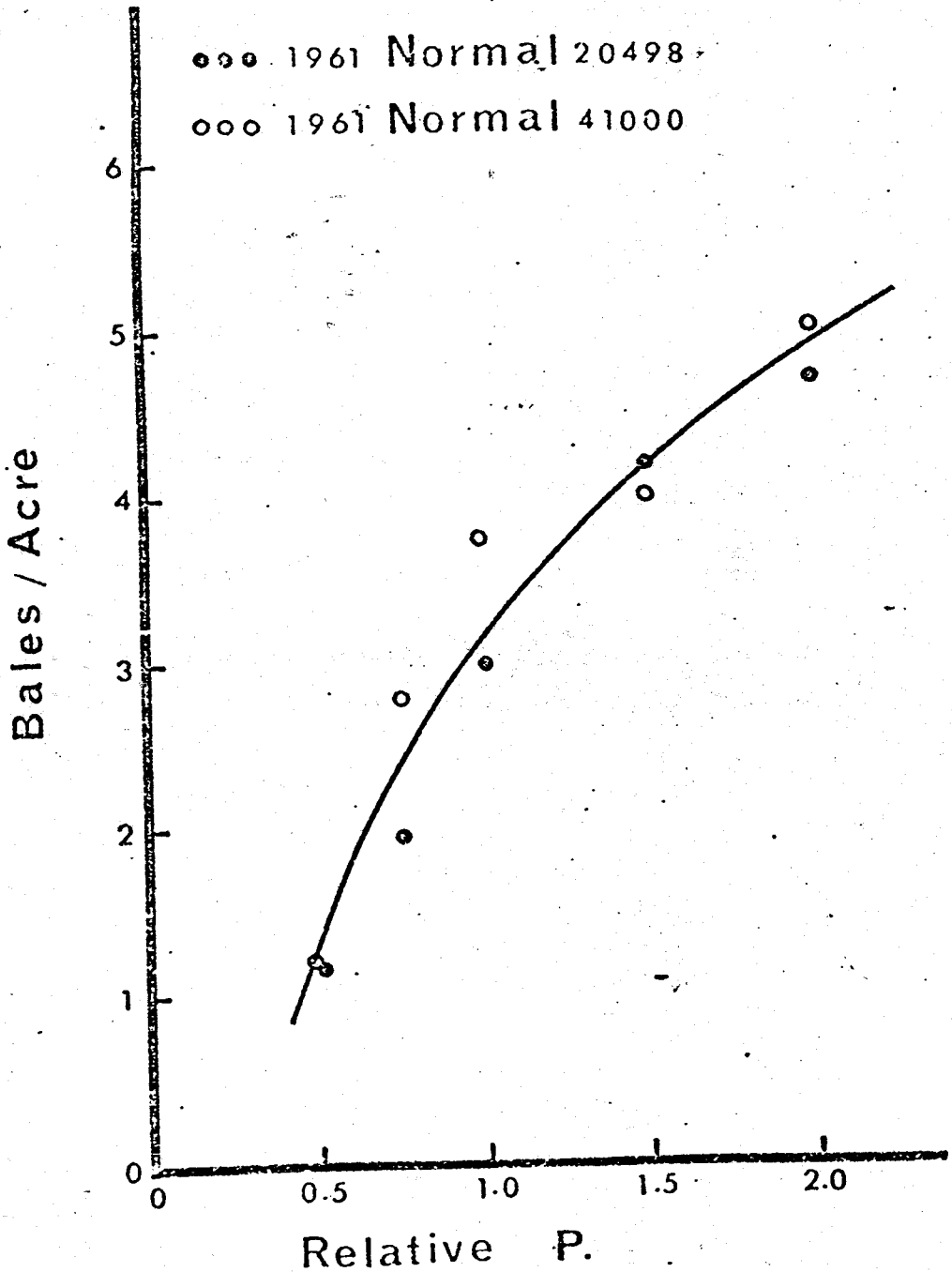
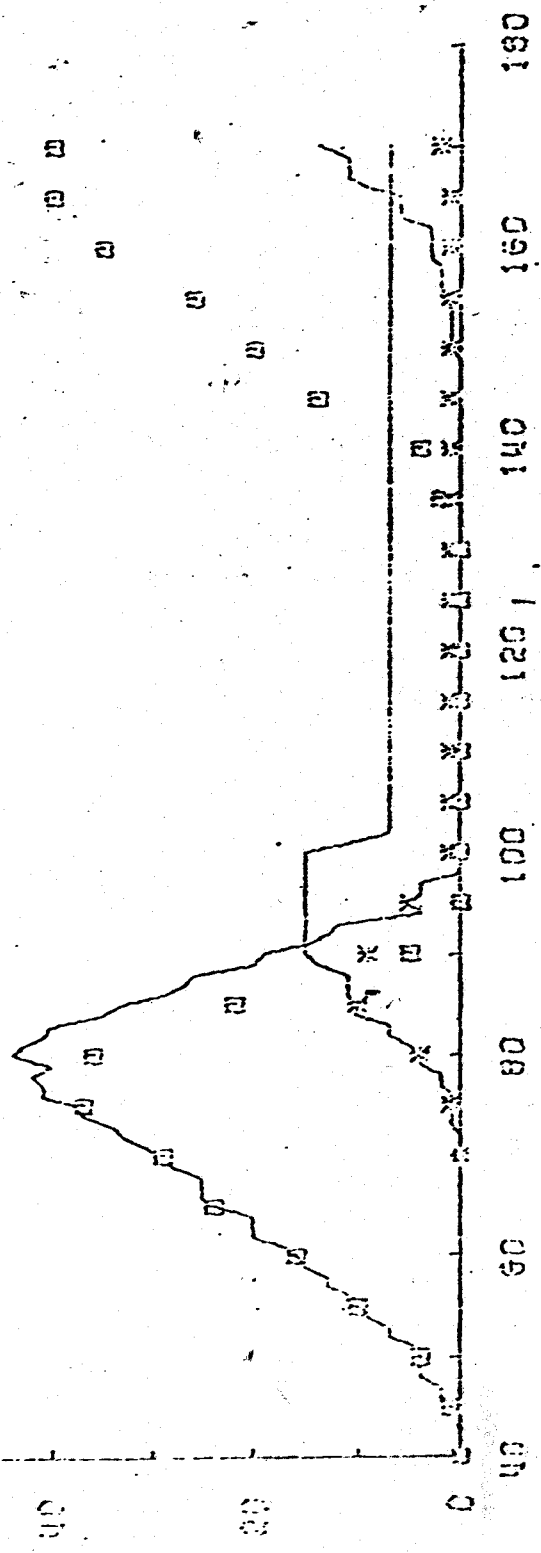

Figure 8.--The relation between seed cotton yield (in bales per acre) and relative photosynthetic efficiency under conditions of perfect insect control and abundant fertilizer and water, at two planting densities.

50 SQUARES
 X TOTAL BOLLS
 ROW 51.0
 POP 82000
 PEFF 1.0
 HI 20
 N2 IRR 67
 YIELD 0.41



DAYS FROM EMERGENCE

Figure 9.--A comparison of fruiting in "narrow row" cotton crop (represented by the \square and * characters) with a "normal" commercial crop (represented by the solid lines). Fertilizer rates, yield and plant population values are on a per acre basis.

Next, we examine a typical computer fertilizer experiment. In figure 11, the application of twenty-two kilograms/ha N at planting application was deleted. The nitrogen stress was more severe, resulting in the loss of ten small bolls instead of eight (shown by the solid line for the standard crop), and yield was decreased somewhat. In figure 12, the sidedressing of N has been increased to 110 kilograms/ha. The abscission of fruit was reduced, but, as in the case of a lower plant population, the crop matured somewhat later. The higher yield prediction was based on the assumption that weather conditions would permit harvest.

Another application of such a model is in the area of system design in terms of crop genotype.¹² One example would be in the substitution of "okra" (i.e., deeply lobed) leaves for the normal leaves. This reduction in leaf area changes canopy light interception, the vegetative sink for metabolites, and the plant's reserve capacity for storage of sugars and nitrogenous compounds. Table 3 shows the predicted results of this change. The model predicts that square abscission will begin earlier in the okra-leafed variety and is much more severe than in the normal-leafed variety. This is also true of the bolls, and a smaller yield is anticipated. This behavior is essentially identical to that observed in the field. The application of luxury supplies of nitrogen is assumed in the model predictions in table 4. Here the crops performed nearly equally although, due to the smaller carbohydrate reserve size in the okra plants, the model predicts a slightly greater loss of squares.

Still another application of crop simulation models is in the study of the effect of climate change on performance and yield. In figure 13B

SOURCES
 TOTAL BELLS
 ROW POP EFF NI N2 IRR YIELD
 150.0 20500 1.0 20 67 0 2.46

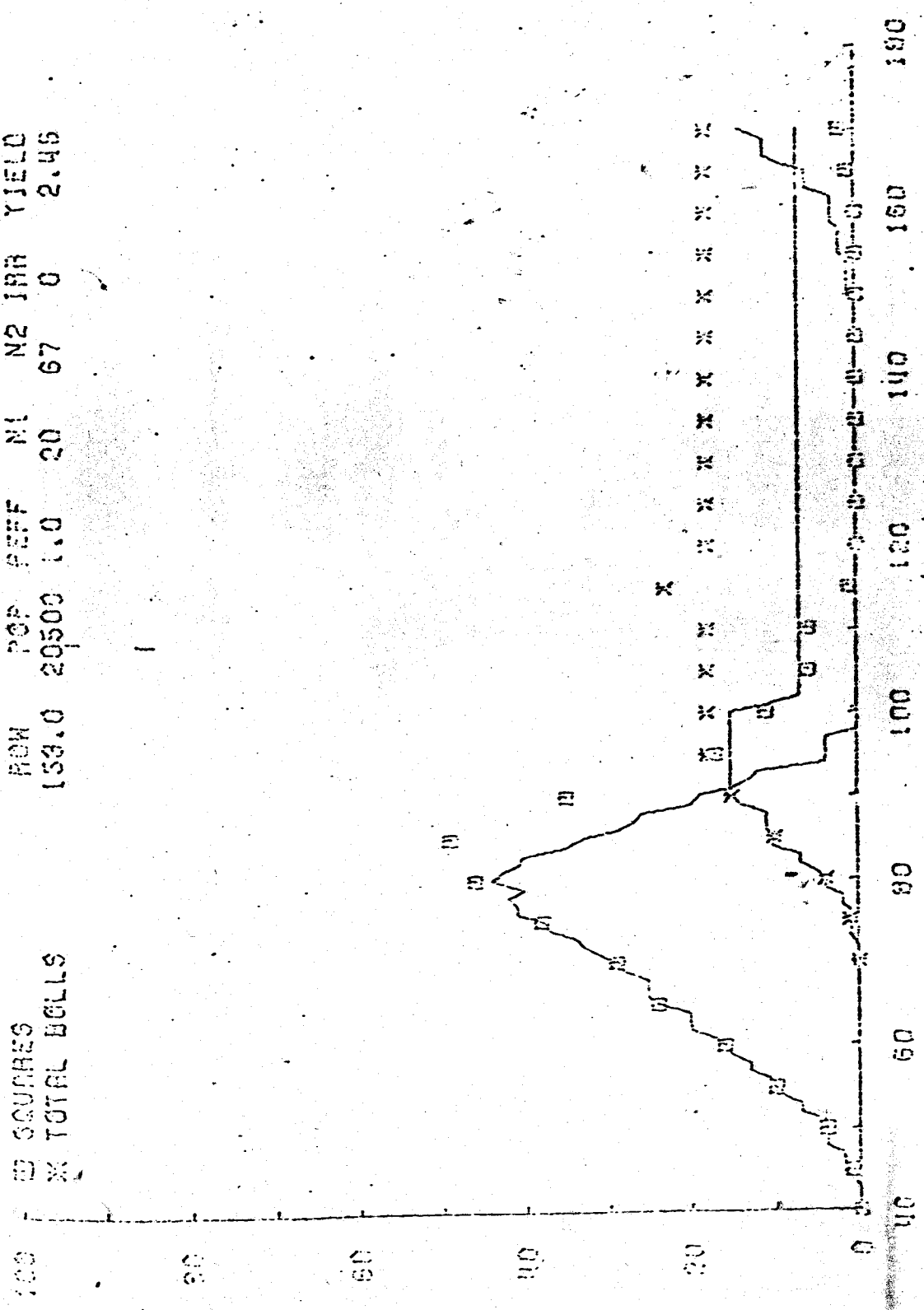

DAYS FROM EMERGENCE

Figure 10.--A comparison of fruiting in "wide row" cotton crop (represented by the □ and * characters) with a "normal" commercial crop (represented by the solid lines). Fertilizer rates, yield and plant population values are on a per acre basis.

100 SQUARES
 * TOTAL BOLLS
 ROW POP PEFF NI N2 IRR YIELD
 101.6 41000 1.0 0 67 0 0.89

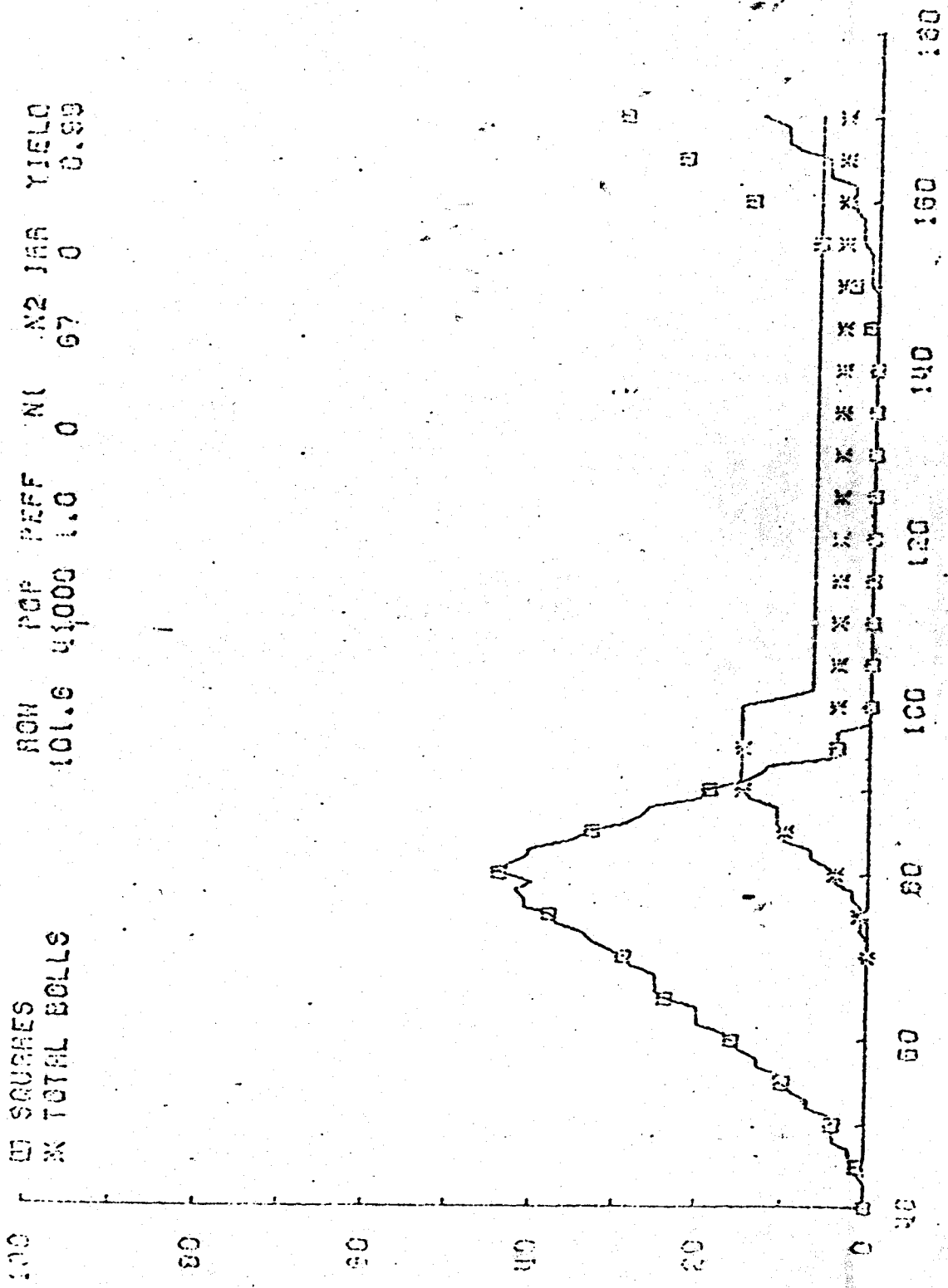

DAYS FROM EMERGENCE

Figure 11.---A comparison of fruiting in a "typical" commercial cotton crop (represented by the solid lines) with that in a crop with no initial application of nitrogen (represented by the \ast and \ast characters). Fertilizer rates, population and yield are on a per acre basis.

100
 80
 60
 40
 20
 0

SQUARES
 TOTAL BOLLS

40W POP PEFF NI N2 IRR YIELD
 101.6 41000 1.0 0 100 0 2.30

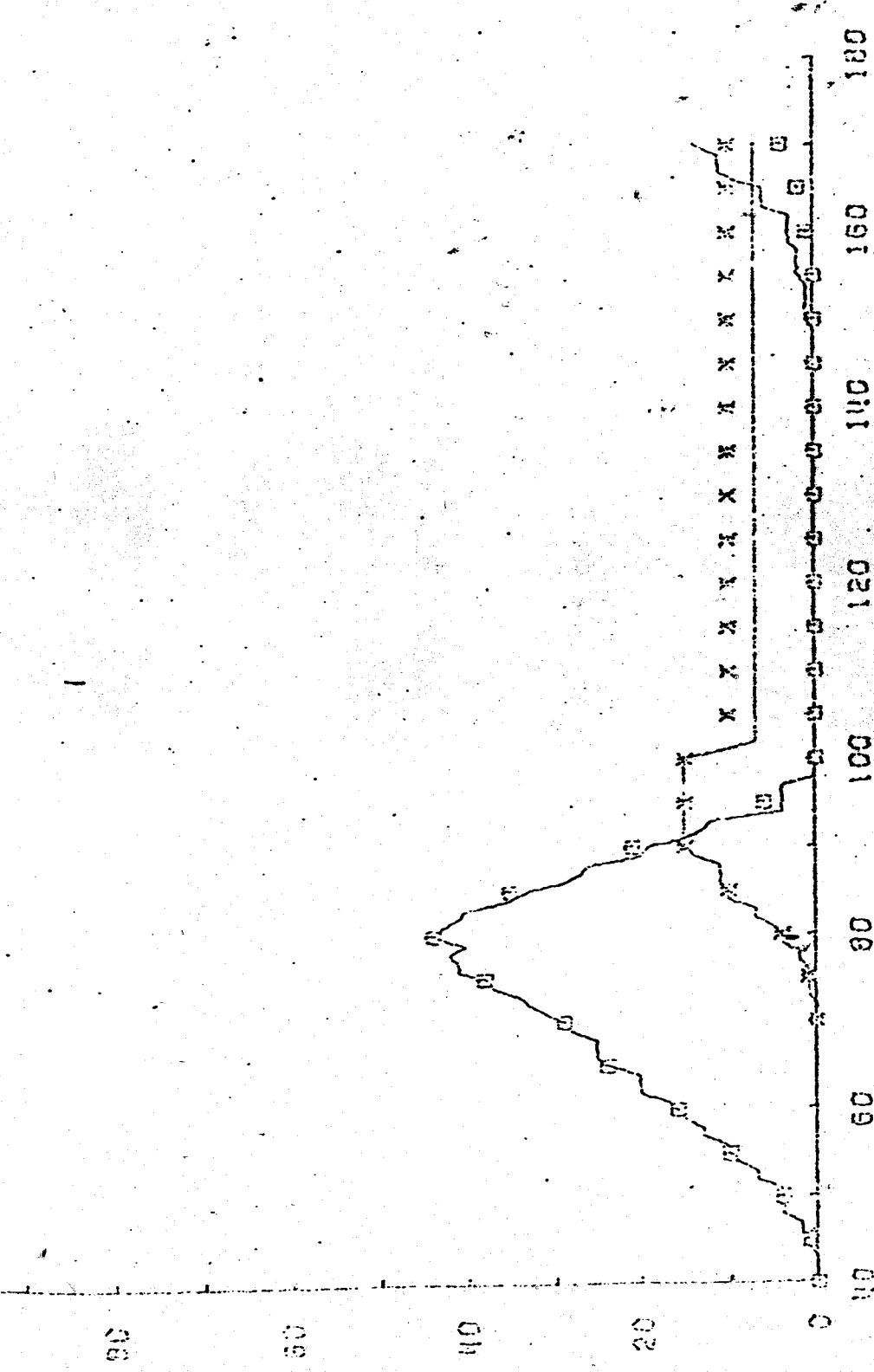

DAYS FROM EMERGENCE

Figure 12.--A comparison of fruiting in a "typical" commercial cotton crop (represented by the solid lines) with that in a crop with no initial fertilizer but with a high application of side-dressed nitrogen (represented by the □ and * characters). Fertilizer rates, population and yield are on a per acre basis.

Table 3. Simulated fruit per plant on normal leaf and okra leaf cotton. Simulation based on 1972 weather data and standard nitrogen level applied to cotton in experimental fields.

Days from emergence	Number of fruit per plant					
	Squares		Green bolls		Open bolls	
	Normal	Okra	Normal	Okra	Normal	Okra
50	4	4	0	0		
60	16	16	0	0		
70	30	29	0	0		
80	45	33	4	4		
90	24	8	15	15		
100	3	0	7	4		
110	0	0	7	4		
120	0	0	7	4		
130	0	0	5	2	2	2
140	0	0	0	0	7	4
150	0	0	0	0	7	4
160	0	0	0	0	7	4
170	0	0	0	0	7	4
Yield (Bales/ha)					4.2	2.22

the input data for the commercial crop discussed earlier have been used. The same simulation is presented in the lines without characters in figures 13A and 13C. Figure 13A shows the results of a run with 2°C added to the daily maximum and minimum temperatures. Figure 13C represents the case with 2°C subtracted. A 2°C increase in temperature speeds the development of the crop by about one week. This is shown both in squares and in boll development. The test crop initiated thirteen bolls and matured eleven, compared with fifteen and seven for the standard run. The plant grown at the higher temperature abscised fewer bolls in response to nitrogen stress. This is partly because of the time of first bloom. The warmer crop had a smaller part of its total nitrogen allotment irretrievably tied up in vegetative tissue. This is indicated by the plant weights at eighty-five days presented in table 5. The model suggests that the crop grown at the higher temperature would have yielded more than the "standard" crop, indicating that the former was carbohydrate sink limited.

A 2°C cooler climate resulted in a week-to-ten-days' delay in development and a great loss of young bolls. The boll abscission, again, is attributable to the larger investment of nitrogen in vegetative plant parts at the beginning of boll set. The cotton farmer would probably compensate this abscission of bolls by increased fertilizer applications, but the lateness of maturity would then be a major problem which would have to be solved by a breeding program to produce a variety that fruits earlier at a given temperature.

Finally, one of the most important applications of crop simulation models is in the determination of economic thresholds in pest and disease

Table 4. Simulated fruit per plant on normal leaf and okra leaf cotton. Simulation based on 1972 weather data and high nitrogen level (150 lbs per acre additional nitrogen above standard level in experimental fields).

Days from emergence	Number of fruit per plant					
	Squares		Green bolls		Open bolls	
	Normal	Okra	Normal	Okra	Normal	Okra
50	4	4	0	0		
60	16	16	0	0		
70	29	29	0	0		
80	44	42	4	4		
90	29	25	15	15		
100	19	12	15	15		
110	13	8	14	14		
120	3	0	14	14		
130	2	0	12	12	2	2
140	0	0	3	3	11	11
150	3	1	0	0	14	14
160	21	4	0	0	14	14
170	42	20	0	0	14	14
Yield (Bales/ha)					7.66	7.41

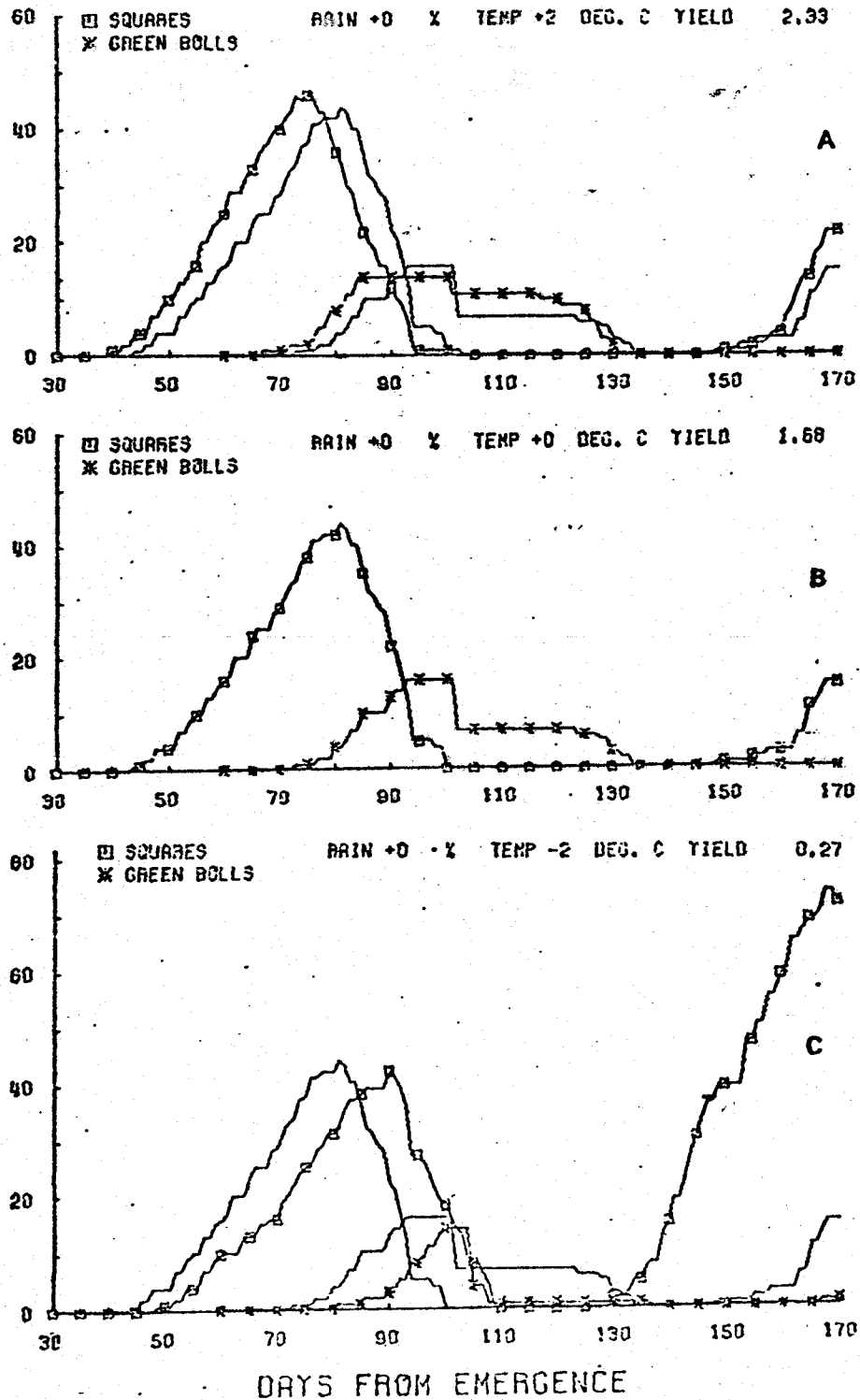

Figure 13.--The effect of temperature change on fruiting in cotton. Solid lines in all figures represent commercial crop of Jenkins (12). \square and $*$ characters represent model predictions. Yields are on a bales per acre basis.

Table 5. Cotton plant weights and node numbers as estimated by SIMCOT II with various temperature inputs.

Temperature		85 Day	85 Day	Final
<u>±</u> °C	Yield*	Weight*	Nodes	Nodes
+ 2°C	2.33	60.1	22	27
0	1.68	62.8	20	25
- 2°C	.27	64.9	18	31

* Plant dry weight is in grams; yield is in bales per acre; nodes refer to the mainstem.

management. Here, the impact of pest or disease control measures on yield are estimated via the model. For example, figure 14 contains crop data from a planting on the Texas High Plains in 1972 by Dr. D. F. Wanjura.¹⁹ The model output suggests that the rate of vegetative development should have been much greater from day 55 to day 105 than was observed. From day 28 to day 38 the crop was afflicted by light hailstorms and sandstorms with visible effects on the leaves and terminal meristems. Perhaps due to this weakening of the plants a blight infection occurred during the next ten-day period, and beginning on day 48 symptoms of verticillium wilt became visible. The model shows that the crop outgrew and recovered from these disturbances by day 120.

Extensive applications of this type are being made of GOSSYM and several derivatives of SIMCOT II to assess the impact of insect populations on growth and yield.^{13, 9} The work underway in our laboratory and elsewhere involves interfacing with the plant models comparable dynamic insect population models.

SUMMARY

The feasibility of building simulation models of crop plant growth and yield has been demonstrated. These models are dynamic materials balances accounting for the major physiological and morphogenetic processes in the crop and soil environment. These models are sufficiently mechanistic that they may serve as a communications medium among scientists providing a means for workers in many disciplines to assess the probable impact of their experiments in understanding and designing crop production systems. Beyond this, the dynamic models of crops offer farmers of the future a tool for crop management decision-making. Among the research

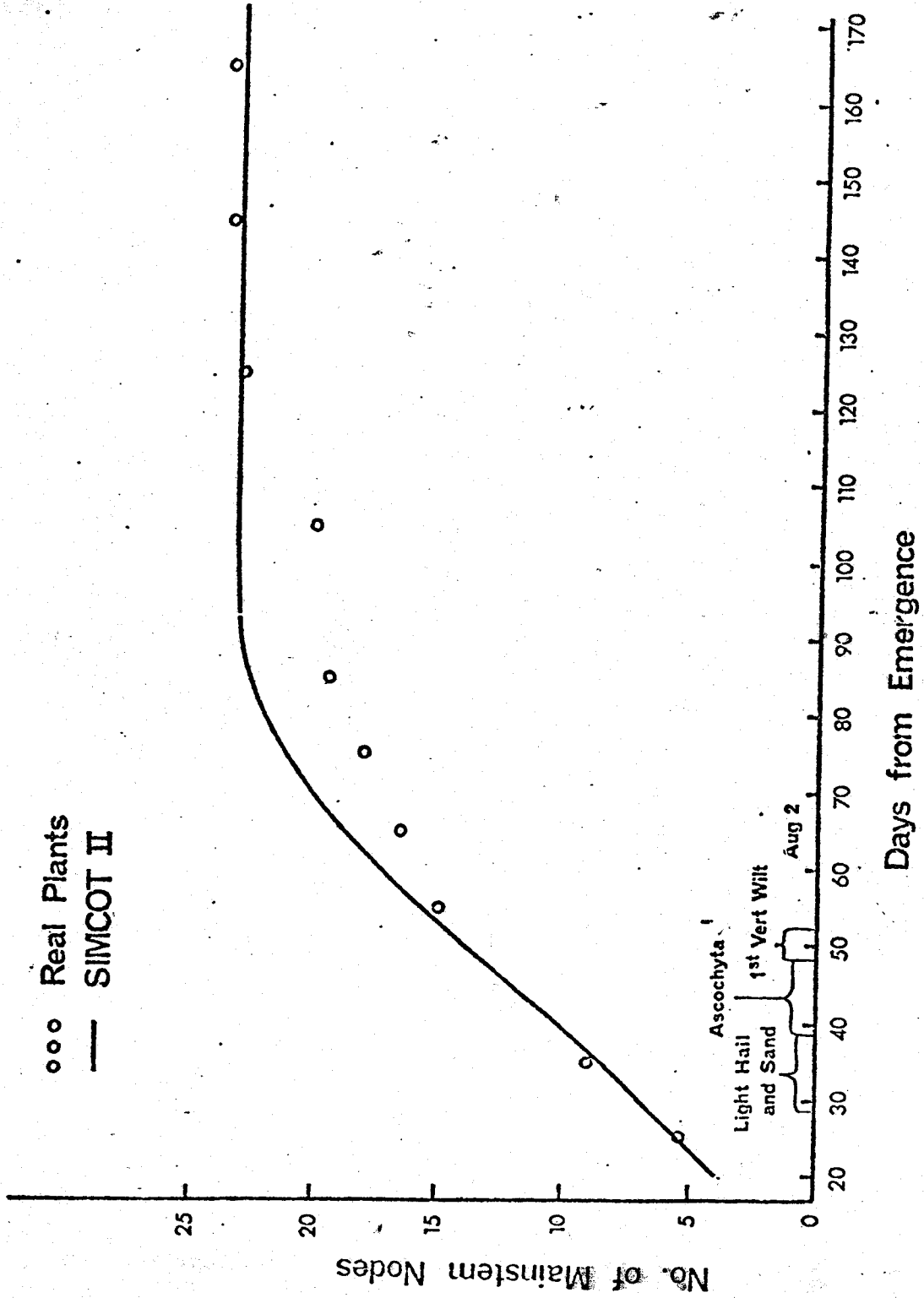

Figure 14.--Vegetative development as predicted by SIMCOT II (solid lines) and as observed by D. F. Manjura (20).

applications to date, we have cited a study of the possible results of photosynthesis research and an analysis of the results of a breeding program to change cotton leaf shape. This suggested that yield losses with okra-leaved cotton may be expected unless special care is taken in the nitrogen fertilization of the crop.

Applications of the type needed by farm managers were demonstrated in fertilizer practices, planting rates, and in the area of disease and pest control. The fertilizer study shows that weather conditions and date of planting must be considered in determining the feasibility of increased nitrogen applications. Similarly, fertility levels should be considered in changing planting density to increase crop earliness.

It is abundantly clear that this application of computers is finding a place both in research and in the management of crop production systems.

NOTES

1. Baker, D. N. (1969) Unpublished data.
2. Baker, D. N., J. R. Lambert, and J. N. Jenkins. (1975) An analysis of the impact of temperature and rainfall changes on growth and yield of delta cottons. In Impacts of Climatic Change in the Biosphere. CIAP Monograph Part 2 - Climatic Effects, Chapter 4.
3. Baker, D. N. and R. B. Musgrave. (1964) Photosynthesis Under Field Conditions V. Further plant chamber studies of the effects of light on corn (Zea mays L.) Crop Sci 4: 127-131.
4. Bruce, R. R. and M. J. M. Romkens. (1965) Fruiting and growth in relation to soil moisture tension. Agron. J. 57: 135-140.
5. De Wit, C. T. (1965) Photosynthesis of leaf canopies. Agr. Res. Rep. 663. Inst. for Biol. and Chem Res. on Field Crops and Herbage. Wageningen.
6. Duncan, W. G., R. S. Loomis, W. A. Williams, and R. Hanau. (1967) A model for stimulating photosynthesis in plant communities. Hilgardia, J. Agric. Sci. 38: 181-205.
7. Fisher, R. A. (1921) Ann. Applied Biol. 7: 367-372. Cross-reference Watson, D. J., 1952. The physiological basis of variation in yield. Adv. Agron. 4: 101-145.
8. Gregory, F. G. (1917) Physiological conditions in cucumber houses. Third Ann. Rep., Experiment and Research Station, Cheshunt, 19-28.
9. Gutierrez, A. P., L. A. Falcon, W. Loew, P. A. Leipzig, and R. van den Bosch. (1975) COTSIM: A model for acala cotton and the effects of defoliators on its yields. Environmenta Ent. 4(1): 125-136.

10. Hesketh, J. D., D. N. Baker and W. G. Duncan. (1972) The simulation of Growth and yield in cotton II. Environmental control of morphogenesis. Crop Sci. 12: 436-439.
11. Hesketh, J. D., K. C. Fry, G. Guinn and J. R. Mauney. (1972) Experimental aspects of growth modeling: potential carbohydrate requirements of cotton bolls. In Modeling the Growth of Trees. (Ed.) C. E. Murphy et. al. EDFB-EBP-72-11. Oak Ridge National Laboratory, Oak Ridge, Tenn. p. 123-127.
12. Jenkins, J. N., D. N. Baker, J. M. McKinion and W. L. Parrott. (1973) Systems analysis and the evaluation of morphogenetic characters in cotton. In Symposium Proceedings on "The Application of Systems Methods to Crop Production," Mississippi State University, June 7-8, 1973. pp. 49-88.
13. McLaughlin, R. E. (1973) The economic threshold and the interface between plant and insect models. In The Application of Systems Methods to Crop Production, Symposium Proc. Mississippi State University, June 7-8, 1973. p. 128-146.
14. Monsi, M. and T. Saeki. (1963) Uber den lichtfaktor in den pflanzengesellschaften und seine bedeutung fur die stoffproduktion. Jap. J. Bot. 14: 22-52.
15. Moss, D. N., R. B. Musgrave, and E. R. Lemon. (1961) Photosynthesis Under Field Conditions III. Some effects of light, carbon dioxide, temperature, and soil moisture on photosynthesis, respiration, and transpiration of corn. Crop Sci. 1: 83-87.
16. Murata, Y. (1961) Studies on photosynthesis in rice plants and its cultural significance. Bul. Nat. Inst. Agric. Sci. Series D. No 9: 1-169.

17. Nichiporovich, A. A. (1954) Photosynthesis and the theory of high crop yields. Fifteenth Timiryazev Lecture - Moskva, Izd. An SSSR. 1956.
18. Ross, Yu K. (1964) Mathematical theory of photosynthesis by a plant cover. DAN SSSR, 157(5): 1239.
19. Tooming, Kh. G. and Yu K. Ross (1964) Radiation regime in maize stands by layers and their description by means of approximate formulas. Issledovaniya po fizike atmosfery Vol. 6, Tartu, Izd. AN Est SSR.
20. Wanjura, D. F. (1972) Personal communication.
21. Watson, D. J. (1947) Comparative physiological studies on the growth of field crops. I. Variation in net assimilation rate and leaf area between species and varieties, and within and between year. Ann. Bot. N. S. 11: 41-76.